

July 19, 2023 Regular Board Meeting Agenda

1. CALL TO ORDER
2. CONSIDER ADOPTION OF AGENDA
3. CLOSED SESSION
4. OPEN SESSION/REPORT ACTION FROM CLOSED SESSION
5. CONSENT CALENDAR
6. STAFF REPORTS
7. REVIEW DISTRICT MEETING DATES/TIMES FOR AUGUST 2023
8. CORRESPONDENCE
9. *Informational Item* RECEIVE UPDATE ON ENGINEERS ESTIMATE FOR WATER TREATMENT PLANT HYPOCHLORITE PROJECT
10. *Action Item* CONSIDER ACCEPTING INFRASTRUCTURE FROM KHOV FOR RETREATS NORTH AND APPROVING RESOLUTION R2023-12
11. *Action Item* CONSIDER APPROVAL OF THE FINANCE AND ADMINISTRATION DIRECTOR JOB DESCRIPTION
12. *Action Item* CONSIDER APPROVAL OF CONTRACT FOR REPAIRS TO LIFT STATION 3B CIP #23-11-02
13. *Action Item* CONSIDER APPROVAL OF CONTRACT WITH LUMOS & ASSOCIATES FOR CAPITAL IMPROVEMENT PLAN AND RATE STUDY CIP #24-200-01 AND CIP #24-250-01
14. *Action Item* CONSIDER APPROVAL OF PURCHASE OF WATER PLANT REPLACEMENT MEMBRANES
15. COMMENTS FROM THE PUBLIC
16. DIRECTOR COMMENTS/SUGGESTIONS
17. ADJOURNMENT



RANCHO MURIETA COMMUNITY SERVICES DISTRICT

15160 JACKSON ROAD
RANCHO MURIETA, CALIFORNIA 95683
916-354-3700
FAX – 916-354-2082

AGENDA

*“Your Independent Local Government Agency Providing
Water, Wastewater, Drainage, Security, and Solid Waste Services”*

REGULAR BOARD MEETING

July 19, 2023

Closed Session 3:30 p.m./Open Session 5:00 p.m.
Rancho Murieta, CA 95683

BOARD MEMBERS

Tim Maybee	President
Martin Pohll	Vice President
Linda Butler	Director
Randy Jenco	Director
Stephen Booth	Director

STAFF

Mimi Morris	General Manager
Michael Fritschi	Director of Operations
Susan Wren	Interim Director of Administration
Andrew Ramos	District General Counsel
Amelia Wilder	District Secretary
Kelly Benitez	Security Supervisor

RANCHO MURIETA COMMUNITY SERVICES DISTRICT

July 19, 2023

REGULAR BOARD MEETING

Call to Order

Closed Session 3:30 p.m./Open Session 5:00 p.m.

Note that this meeting will be held in-person at the address set forth above, and not via videoconference. In order to comply with the State's COVID-related Guidance for the use of face coverings, it is strongly recommended that all persons, regardless of vaccination status, continue to mask while in indoor public settings and businesses.

All persons present at District meetings will place their cellular devices in silent and/or vibrate mode (no ringing of any kind). During meetings, these devices will be used only for emergency purposes and, if used, the party called/calling will exit the meeting room for conversation. Other electronic and internet enabled devices are to be used in the "silent" mode. Under no circumstances will recording devices or problems associated with them be permitted to interrupt or delay District meetings.

AGENDA

ESTIMATED RUNNING TIME 5:00

1. CALL TO ORDER - Determination of Quorum – President Maybee **(Roll Call)**

2. CONSIDER ADOPTION OF AGENDA **(Motion)**

The Board will discuss items on this agenda, and may take action on those items, including informational items and continued items. No action or discussion will be undertaken on any item not appearing on the agenda, except that (1) directors or staff may briefly respond to statements made or questions posed during public comments on non-agenda items, (2) directors or staff may ask a question for clarification, make a brief announcement, or make a brief report on his or her own activities, (3) a director may request staff to report back to the Board at a subsequent meeting concerning any matter or request staff to place a matter on a future Board meeting agenda, and (4) the Board may add an item to the agenda by a two-thirds vote determining that there is a need to take immediate action and that the need for action came to the District's attention after posting the agenda.

*The running times listed on this agenda are only estimates and may be discussed earlier or later than shown. At the discretion of the Board, an item may be moved on the agenda and or taken out of order. **TIMED ITEMS** as specifically noted, such as Hearings or Formal Presentations of community-wide interest, will not be taken up earlier than listed.*

3. CLOSED SESSION

- A. Conference with Legal Counsel – Existing Litigation (Gov. Code, § 54956.9(d)(1)) – *Tompkins v. Rancho Murieta CSD*
- B. Conference with legal counsel concerning significant exposure to litigation pursuant to Gov. Code 54956.9(d)(2) and (e)(1) (one case) and potential initiation of litigation pursuant to Gov. Code 54956.9(d)(4) (one case)
- C. Public employee performance evaluation of the General Manager (Gov. Code section 54957).

4. OPEN SESSION/REPORT ACTION FROM CLOSED SESSION

5. CONSENT CALENDAR (Motion) (Roll Call Vote) (5 min.) All items in this agenda item will be approved as one motion if they are not excluded from the motion adopting the consent calendar.

A. Approval of Board Meeting and Committee Meeting Minutes

1. *June 21, 2023 Regular Board Meeting Minutes*
2. *July 5, 2023 Improvements Committee Meeting Minutes*

B. Approval of District Appointments

- a. Melinda Morris as District Treasurer
- b. Melinda Morris as Regional Water Authority (RWA) Board Member Representative (Director Maybee is currently the second RWA Board Member Representative)
- c. Melinda Morris as Sacramento Ground Water Authority Board Member Representative
- d. Melinda Morris as Designated Labor Negotiator
- e. Melinda Morris as Real Property Negotiator

C. Bills Paid Listing

6. STAFF REPORTS (Receive and File)

- A. General Manager's Report**
- B. Security Report**
- C. Utilities Report**

7. REVIEW DISTRICT MEETING DATES/TIMES FOR AUGUST 2023

- A. Improvements – August 1, 2023 at 8:00 a.m.**
- B. Finance – Canceled**
- C. Communications – Postponed until December**
- D. Security – Committee will meet as needed**
- E. Special Board Meeting – August 15 – Open Session at 2:00 p.m.**
- F. Regular Board Meeting – August 16, 2023 - Open Session at 5:00 p.m.**

8. CORRESPONDENCE

- A. Email from Beth Buderus**

9. *Informational Item* RECEIVE UPDATE ON ENGINEERS ESTIMATE FOR WATER TREATMENT PLANT HYPOCHLORITE PROJECT (Discussion)

10. *Action Item* CONSIDER ACCEPTING INFRASTRUCTURE FROM KHOV FOR RETREATS NORTH AND APPROVING RESOLUTION R2023-12 (Discussion/Action) (Motion) (Roll Call Vote)

11. *Action Item* CONSIDER APPROVAL OF THE FINANCE AND ADMINISTRATION DIRECTOR JOB DESCRIPTION (Discussion/Action) (Motion) (Roll Call Vote)

12. *Action Item* CONSIDER APPROVAL OF CONTRACT FOR REPAIRS TO LIFT STATION 3B CIP #23-11-02 (Discussion/Action) (Motion) (Roll Call Vote)

13. *Action Item* CONSIDER APPROVAL OF CONTRACT WITH LUMOS & ASSOCIATES FOR CAPITAL IMPROVEMENT PLAN AND RATE STUDY CIP #24-200-01 AND CIP #24-250-01
(Discussion/Action) (Motion) **(Roll Call Vote)**

14. *Action Item* CONSIDER APPROVAL OF PURCHASE OF WATER PLANT REPLACEMENT MEMBRANES (Discussion/Action) (Motion) **(Roll Call Vote)**

15. COMMENTS FROM THE PUBLIC

Members of the public may comment on any item of interest within the subject matter jurisdiction of the District and any item specifically agendized. Members of the public wishing to address a specific agendized item are encouraged to offer their public comment during consideration of that item. With certain exceptions, the Board may not discuss or take action on items that are not on the agenda.

If you wish to speak during Comments from the Public or would like to comment regarding an item appearing on the meeting agenda, please complete a public comment card and submit to the Board Secretary prior to the point in the meeting at which the item is called. Speakers presenting individual opinions shall have 3 minutes to speak. Speakers presenting opinions of groups or organizations shall have 5 minutes per group.

16. DIRECTOR COMMENTS/SUGGESTIONS

In accordance with Government Code 54954.2(a), directors and staff may make brief announcements or brief reports of their own activities. They may ask questions for clarification, make a referral to staff or take action to have staff place a matter of business on a future agenda.

17. ADJOURNMENT (Motion)

In accordance with California Government Code Section 54957.5, any writing or document that is a public record, relates to an open session agenda item and is distributed less than 24 hours prior to a special meeting, will be made available for public inspection in the District offices during normal business hours. If, however, the document is not distributed until the regular meeting to which it relates, then the document or writing will be made available to the public at the location of the meeting.

In compliance with federal and state laws concerning disabilities, if you are an individual with a disability and you need a disability-related modification or accommodation to participate in this meeting or need assistance to participate in this meeting, please contact the District Office at 916-354-3700 or awilder@rmcsd.com. Requests must be made as soon as possible.

Note: This agenda is posted pursuant to the provisions of the Government Code commencing at Section 54950. The date of this posting is July 14, 2023. Posting locations are: 1) District Office; 2) Rancho Murieta Post Office; 3) Rancho Murieta Association; 4) Murieta Village Association.



RANCHO MURIETA COMMUNITY SERVICES DISTRICT REGULAR BOARD MEETING MINUTES

June 21, 2023

Closed Session 4:00 p.m./Open Session 5:00 p.m.

1. CALL TO ORDER/ROLL CALL

President Maybee called the Regular Board Meeting of the Board of Directors of Rancho Murieta Community Services District to order at 4:00 p.m. in the District meeting room, 15160 Jackson Road, Rancho Murieta. Director's present at the District office were Timothy Maybee, Linda Butler, and Stephen Booth. Director's Martin Pohll, and Randy Jenco, were absent. Also present at the District office were Mimi Morris, General Manager; Michael Fritschi, Director of Operations; Kelly Benitez, Security Supervisor; Travis Bohannon, Chief Plant Operator; Andrew Ramos, District General Counsel; and Amelia Wilder, District Secretary.

2. CONSIDER ADOPTION OF AGENDA

Motion/Maybee to adopt the Agenda with the removal of item #17 Consider adopting resolution R2023-10 for CalPERS 180 day wait period exception for Donna McLeod as Accounting Technician. **Second/Booth.**

Roll Call Vote: Ayes: Maybee, Butler, Booth. Noes: None. Absent: Pohll, Jenco. Abstain: None.

3. BOARD ADJOURNED TO CLOSED SESSION TO DISCUSS THE FOLLOWING ITEMS:

- A. Conference with legal counsel concerning significant exposure to litigation pursuant to Gov. Code 54956.9(d)(2) and (e)(1) (one case) and potential initiation of litigation pursuant to Gov. Code 54956.9(d)(4) (one case)
- B. Public employee performance evaluation of the General Manager (Gov. Code section 54957).

4. OPEN SESSION/REPORT ACTION FROM CLOSED SESSION

Director Maybee reported that no decisions were made, direction was given to Staff.

5. CONSENT CALENDAR

Motion/Maybee to approve Consent Calendar. **Second/Booth.** **Roll Call Vote: Ayes: Maybee, Butler, Booth. Noes: None. Absent: Pohll, Jenco. Abstain: None.**

6. STAFF REPORTS

Under Agenda Item 6A, Mimi Morris, General Manager, gave a summary of activities during the previous month, highlighting the following topics:

- Administration
 - General Staffing Update
 - FEMA Disaster Relief
 - Drought Relief Water Reclamation Grants
- Conference/Educational Opportunities
 - Sacramento Regional Wastewater Tour
 - Upcoming Trainings and Recent Employee Trainings
 - Exams Passed
- Development
 - Residences East

- Retreats North
- Pet Hospital
- Riverview
- Outreach & Regional Communication
 - Grand Jury Report Responses

Under Agenda Item 4B, Ms. Morris presented the Bills Paid Listing, a discussion followed.

Under Agenda Item 4C, Kelly Benitez, Security Supervisor, updated the Board with a summary of August's activities in the Security Department, including:

- Operations Update
- Rancho Murieta Association Activity
- Community Meetings
- Incidents of Note
- RMA Violation Report
- Gate Entries Denied Reports
- Cases by Breakdown Report

There was a discussion about the upcoming 4th of July events.

Under Agenda Item 6D, Travis Bohannon, Chief Plant Operator, gave a summary of the utility update, including:

- Water Treatment Facility
- Water Consumption
- Raw Water Storage & Delivery
- Wastewater Facility
- Utility Crew Report
- Capital Projects
 - SB 170 Funded Projects
 - Water Treatment Facility
 - Integrated Water Master Plan
 - Lift Stations
 - 3B
 - Alameda & Starter Shack
 - Cantova & FAA
 - 6B

7. REVIEW DISTRICT MEETING DATES/TIMES FOR JUNE/JULY 2023

No changes.

8. CORRESPONDENCE

Director Maybee acknowledged the correspondence in the packet. Janis Eckard addressed the Board and gave them a packet of information.

9. CONSIDER ADOPTING ORDINANCE O2023-03 INCREASING WATER, SEWER AND SOLID WASTE SERVICE CHARGES AND STORM DRAINAGE AND SECURITY SPECIAL TAXES

Ms. Morris briefly discussed the Ordinance and the changes to the rates. **Motion/Maybee** to adopt Ordinance O2023-03 increasing water, sewer and solid waste service charges and storm drainage and security special taxes. Director Booth repeated his concerns with the rate increases. **Second/Butler**. **Roll Call Vote: Ayes: Maybee, Butler, Booth. Noes: None. Absent: Pohll, Jenco. Abstain: None.**

10. CONSIDER ADOPTING RESOLUTION R2023-08 APPROVING THE PROPOSED BUDGET FOR FISCAL YEAR 2023-24, INCLUDING CAPITAL PROJECTS

Motion/Booth to adopt Resolution R2023-08 approving the proposed budget for fiscal year 2023-24, including Capital Projects, and reiterated his concerns stated during item #9. **Second/Maybee**. Director Butler expressed her concerns with a budget that shows a deficit. Director Booth expressed his concerns with the lack of a year to date financial statement. **Roll Call Vote: Ayes: Maybee, Butler, Booth. Noes: None. Absent: Pohll, Jenco. Abstain: None.**

11. CONSIDER APPROVAL OF DRAFT BOARD RESPONSE TO THE COMMUNITY REGARDING THE 2022-2023 SACRAMENTO COUNTY GRAND JURY REPORT

Ms. Morris briefly discussed the Grand Jury Report response to the Community that will be posted on the District's website. **Motion/Booth** to approve Draft Board Response to the Community regarding the 2022-2023 Sacramento Grand Jury Report. **Second/Maybee**. **Roll Call Vote: Ayes: Maybee, Butler, Booth. Noes: None. Absent: Pohll, Jenco. Abstain: None.**

12. CONSIDER APPROVAL OF THE SAFETY CENTER REPLACEMENT

Amelia Wilder, District Secretary updated the Board with quotes to replace the Safety Center. The Board decided that with the current budget situation they would like to have a source of funds before approving the project. Staff were instructed to ask for an extension of the quote. **Motion/Booth** to table this item Board meeting in August. **Second/Maybee**. **Roll Call Vote: Ayes: Maybee, Butler, Booth. Noes: None. Absent: Pohll, Jenco. Abstain: None.**

13. CONSIDER REQUEST FROM KHOV FOR PARTIAL FUNDING ON LIFT STATION 6B

Ms. Morris and Mr. Fritschi presented the Board with this topic. There was a discussion. **Motion/Maybee** to approve Resolution R2023-11 authorizing the District to reimburse K Hovnanian Homes to Increase Capacity of District Lift Station 6B in the amount of \$85,633.14, to include a \$43,987.14 reduction of Capital Sewer Fees for Connections to 62 Lots in Retreats West and East and \$41,646 from the Sewer Improvement Fund in cash to offset the costs that the District would pay to upgrade Lift Station 6b, and to approve CIP#23-24-02, appropriate funds in the amount of \$41,646 and authorize the General Manager to reimburse K Hovnanian Homes on behalf of the District. **Second/Butler**. **Roll Call Vote: Ayes: Maybee, Butler, Booth. Noes: None. Absent: Pohll, Jenco. Abstain: None.**

14. CONSIDER ADOPTING CHANGES TO UTILITY WORKER AND OPERATOR JOB DESCRIPTIONS

Mr. Fritschi updated the Board on this topic. Director Booth asked that we review this change with OE-3. **Motion/Booth** to approve changes to the Utility Worker and Operator Job Descriptions. **Second/Maybee**. **Roll Call Vote: Ayes: Maybee, Butler, Booth. Noes: None. Absent: Pohll, Jenco. Abstain: None.**

15. CONSIDER VOTING FOR CSDA ELECTION

Motion/Maybee to vote for Nicholas Schneider for CSDA Board of Directors seat C position. **Second/Butler.**
Roll Call Vote: Ayes: Maybee, Butler, Booth. Noes: None. Absent: Pohll, Jenco. Abstain: None.

16. CONSIDER APPROVAL FOR PURCHASE OF A COMMUNOTOR FOR MAIN LIFT NORTH DIRECTOR

Mr. Fritschi updated the Board on this project. **Motion/Maybee** to adopt Resolution R2023-09, and enter into an agreement with JWC Environmental for replacement of the Main Lift North Communitor, approve CIP#23-23-02 and appropriate funds in the amount of \$30,918 and authorize General Manager to execute the agreement on behalf of the District. **Second/Butler. Roll Call Vote: Ayes: Maybee, Butler, Booth. Noes: None. Absent: Pohll, Jenco. Abstain: None.**

17. CONSIDER ADOPTING RESOLUTION R2023-10 FOR CALPERS 180 DAY WAIT PERIOD EXCEPTION FOR DONNA MCLEOD AS ACCOUNTING TECHNICIAN

This item was removed from the agenda.

18. COMMENTS FROM THE PUBLIC

None.

19. DIRECTOR COMMENTS/SUGGESTIONS

Director Butler thanked Staff for the discussions.

Director Maybee thanked Staff and commented on Organic Waste cans and RMA compliance.

20. ADJOURNMENT

Motion/Maybee to adjourn at 7:30 p.m. **Second/Butler. Roll Call Vote: Ayes: Maybee, Butler, Booth. Noes: None. Absent: Pohll, Jenco. Abstain: None.**

Respectfully submitted,

Amelia Wilder
District Secretary

MEMORANDUM

Date: July 12, 2023
To: Board of Directors
From: Improvements Committee Staff
Subject: July 5, 2023, Special Improvements Committee Meeting Minutes

1. CALL TO ORDER

Director Jenco called the meeting to order at 8:00 a.m. Present were Directors Jenco and Pohll. Present from District staff were Mimi Morris, General Manager; Michael Fritschi, Director of Operations; Travis Bohannon, Chief Plant Operator; Lisa Maddaus from Maddaus Water Management, Inc. and Amelia Wilder, District Secretary.

2. PRESENT PHASE ONE INTEGRATED WATER MASTER PLAN STORY MAP

Lisa Maddaus, Partner/Chief Financial Officer, Maddaus Water Management, Inc., presented the Story Board that has been prepared. The next step will be a presentation at the August 216, 2023 Board meeting. ***This item will be on the August 16, 2023 Board Agenda.***

3. MONTHLY UPDATE

Mr. Fritschi gave a summary of the Utilities Department Update with a discussion on the following topics:

- a. Lost Lake Maintenance
- b. Drainage Ditch Maintenance
- c. Level Sensors for District Reservoirs
- d. Dissolved Air Flotation (DAF) Pump Replacement
- e. Wastewater Drying Bed Panel Update
- f. Retreats Infrastructure Acceptance
- g. SB170 Project Update
- h. Annual Wastewater Sludge Removal

4. PUBLIC COMMENT

Resident John Merchant commented on the pipes that go up to Stonehouse Park. A discussion followed. Mr. Merchant also commented that he did not believe that the District could utilize water in Clementia for potable uses.

5. DIRECTOR AND STAFF COMMENTS/SUGGESTIONS

None.

6. ADJOURNMENT

The meeting was adjourned at 9:09 a.m.

DATE: July 14, 2023
FROM: Susan Wren, Interim Director of Administration
SUBJECT: Receive and File Check Journal

Attached is a list of checks numbered 11191 through 11256 issued between June 1, 2023 and June 30, 2023. Invoices were presented by departments, reviewed by administration staff and subsequent checks were issued. All checks were in conformity with the District's policies and procedures. Monies were available to pay the amounts listed.

The Board is asked to receive and file this information.

FISCAL ANALYSIS

Sixty-six (66) checks totaling \$451,661.19 were issued and one check was voided between June 1, 2023 and June 30, 2023.

ATTACHMENT

Accounts Payable Vendor Check Register Report from June 1, 2023 through June 30, 2023.

System: 7/14/2023 12:41:45 PM RANCHO MURIETA CSD
User Date: 7/14/2023 VENDOR CHECK REGISTER REPORT User ID:

Page:
CHRIS

Payables Management

Ranges: From: To: From: To:
Check Number First Last Check Date 6/1/2023
Vendor ID First Last Checkbook ID First
Vendor Name First Last
Sorted By: Check Date
* Voided Checks

Check Number	Check Date	Vendor	Checkbook ID	Amount
11191	6/16/2023	Zenon Environmental Corporation	CSD CHECKING	12,483.90
11192	6/19/2023	A&D Automatic Gate and Access	CSD CHECKING	267.50
11193	6/19/2023	ABS Direct	CSD CHECKING	1,492.44
11194	6/19/2023	Applications By Design, Inc.	CSD CHECKING	1,260.00
11195	6/19/2023	Aramark Uniform & Career Apparel, LLC	CSD CHECKING	256.49
11196	6/19/2023	Bartkiewicz, Kronick & Shanahan	CSD CHECKING	8,580.11
11197	6/19/2023	Caltronics	CSD CHECKING	166.67
11198	6/19/2023	California Waste Recovery Systems	CSD CHECKING	89,395.90
11199	6/19/2023	Central Valley Salinity Coalition	CSD CHECKING	3,466.02
11200	6/19/2023	Chemtrade Chemicals US LLC	CSD CHECKING	3,658.34
11201	6/19/2023	Clark Pest Control	CSD CHECKING	739.00
11202	6/19/2023	Corelogic Solutions, LLC	CSD CHECKING	225.10
11203	6/19/2023	Fastsigns	CSD CHECKING	344.09
11204	6/19/2023	Ferguson Enterprises, Inc 1423	CSD CHECKING	538.75
11205	6/19/2023	Galls/Quartermaster	CSD CHECKING	3,391.80
11206	6/19/2023	Intelligent Technical Solutions, LLC	CSD CHECKING	7,350.08
11207	6/19/2023	Lund Construction	CSD CHECKING	15,522.80
11208	6/19/2023	LUXURY CLEANING SERVICE	CSD CHECKING	2,000.00
11209	6/19/2023	Mel Outram	CSD CHECKING	21.12
11210	6/19/2023	N.J McCutchen, Inc.,	CSD CHECKING	22,830.00
11211	6/19/2023	Pace Supply Corp	CSD CHECKING	952.60
11212	6/19/2023	S. M. U. D.	CSD CHECKING	25,902.68
11213	6/19/2023	Travis Bohannon	CSD CHECKING	193.75
11214	6/19/2023	Useware, Inc.	CSD CHECKING	1,900.00
11215	6/19/2023	Valley Oak Press, Inc.	CSD CHECKING	250.00
11216	6/19/2023	waterTALENT LLC	CSD CHECKING	10,400.00
11217	6/19/2023	W.W. Grainger Inc.	CSD CHECKING	2,430.83
11218	6/19/2023	Zep Sales & Service	CSD CHECKING	68.11
11219	6/29/2023	Accounting & Association Software Group	CSD CHECKING	330.00
11220	6/29/2023	Aramark Uniform & Career Apparel, LLC	CSD CHECKING	172.26
11221	6/29/2023	Borges & Mahoney	CSD CHECKING	1,725.84
11222	6/29/2023	Brower Mechanical, Inc	CSD CHECKING	650.10
11223	6/29/2023	California Laboratory Services	CSD CHECKING	3,221.20
11224	6/29/2023	Camberos Landscaping	CSD CHECKING	770.00
11225	6/29/2023	Chemtrade Chemicals US LLC	CSD CHECKING	7,523.82
11226	6/29/2023	Cisco Air Systems, Inc	CSD CHECKING	2,095.50
11227	6/29/2023	Concentra DBA Occupational Health Centers o	CSD CHECKING	126.00
11228	6/29/2023	Daily Journal Corporation	CSD CHECKING	2,371.50
11229	6/29/2023	Dewberry Engineers Inc.	CSD CHECKING	7,063.50
11230	6/29/2023	Domenichelli and Associates, Inc	CSD CHECKING	2,010.00
11231	6/29/2023	Domino Solar LTD	CSD CHECKING	63,789.71
11232	6/29/2023	Galls/Quartermaster	CSD CHECKING	655.76
11233	6/29/2023	Greenfield Communications	CSD CHECKING	448.99
11234	6/29/2023	Industrial Electrical Company	CSD CHECKING	256.77
11235	6/29/2023	James Colas	CSD CHECKING	400.00
11236	6/29/2023	Kirby's Pump & Mechanical	CSD CHECKING	9,680.00
11237	6/29/2023	Pace Supply Corp	CSD CHECKING	882.80
11238	6/29/2023	Prodigy Electric & Controls Inc.	CSD CHECKING	49,525.00
11239	6/29/2023	Sierra Office Supplies	CSD CHECKING	64.65

	11240	6/29/2023	Solitude Lake Management LLC	CSD CHECKING	2,275.00
	11241	6/29/2023	Streamline	CSD CHECKING	300.00
	11242	6/29/2023	Terry Radovich	CSD CHECKING	1,263.41
	11243	6/29/2023	Tesco Controls, Inc.	CSD CHECKING	3,840.00
	11244	6/29/2023	Thatcher Company of California, Inc	CSD CHECKING	11,492.00
	11245	6/29/2023	The Pun Group, LLC	CSD CHECKING	23,767.50
	11246	6/29/2023	Tyler Technologies, INC	CSD CHECKING	8,937.50
* Voided Checks	11247	6/29/2023	Univar Solutions USA Inc	CSD CHECKING	8,078.02
	11248	6/29/2023	Univar USA Inc.	CSD CHECKING	6,113.13
	11249	6/29/2023	Walker's Office Supplies, Inc	CSD CHECKING	491.43
	11250	6/29/2023	Warlito Gabriel	CSD CHECKING	473.75
	11251	6/29/2023	Watchdogs Surveillance	CSD CHECKING	5,905.94
	11252	6/29/2023	waterTALENT LLC	CSD CHECKING	9,230.00
	11253	6/29/2023	Travis Bohannon	CSD CHECKING	200.00
	11254	6/29/2023	Univar Solutions USA Inc	CSD CHECKING	4,961.16
	11255	6/29/2023	Mark Copeland	CSD CHECKING	183.89
	11256	6/29/2023	Alchemy Consulting Group, LLC	CSD CHECKING	2,375.00

Total Checks:		66	Total Amount of Checks:		\$ 451,661.19

MEMORANDUM

Date: July 10, 2023
To: Board of Directors
From: Mimi Morris, General Manager
Subject: General Manager's Report to the Board of Directors

ADMINISTRATION

GENERAL STAFFING UPDATE

The District expects to initiate a formal recruitment for the Finance and Administration Director upon approval of the job description by the full board today. The position is being restructured to encompass both administration and financial management. The Accounting Manager position will be eliminated. This is a return to a staffing model that existed over ten years ago.

The District is pleased to announce the addition of Ryan Abarca as our new full time Utility Workers. He began on the 26th of June.

Staff have been working to reconcile Employee Vacation Leave Credit Balances with our automated payroll system's records.

There were several factors involved in the Vacation Leave Credit imbalances.

A primary factor was the transition to the automated PayChex system in January of 2020. Upon transition to that system, staff were not provided with their leave balance information and leave credit usage on their paystubs, as required by state and federal law. This was an ongoing issue for staff over the last three and a half years and a source of great frustration, as noted in the employee surveys. This lack of reporting was corrected with the June 7th paychecks after the payroll technician was directed to ask PayChex if their system allowed for that functionality.

The lack of leave credit visibility, however, made it difficult for staff to track their balances over the last three and a half years.

An additional factor which resulted in the extensive Vacation Leave Credit imbalances was an improper interpretation and application of the Vacation Leave Credit policy. The policy, which exists in both the Personnel Manual and the MOU, includes a maximum allowable balance. If an employee reaches the maximum balance, the employee is to no longer receive leave credits until such time as his/her balance is below the maximum allowable balance.

The policy was incorrectly interpreted to mean that employees' balances would be reduced to the maximum allowable balance and deductions were made to achieve that goal. Several employees had large deductions incorrectly made from their balances instead of suspending their accrual of vacation leave credits until they had reduced their balances to the maximum allowable levels. Because staff were not provided with their leave credit information on their checks, staff had difficulty knowing what their balances were and staying below the maximum allowable balance.

Another factor was the use of incorrect accrual rates for multiple employees. The January 2021 OE3 MOU includes the accrual rates for vacation leave credits as does the October 2021 Personnel Manual. These rates are not in alignment, and this led to errors in calculating the vacation leave credits.

This effort was completed the week of July 10th and staff is being informed of any over or understatement of their accounts. Employee records in PayChex are being updated to reflect the fully validated amounts and the PayChex accrual rates were also verified so that the vacation leave credit balances going forward will be accurate. Staff will reconcile internal records with the PayChex records each month for six months to ensure that the system is functioning properly and will drop down to annual reviews thereafter.

FINANCIAL UPDATE

The FY20-21 Audit is nearing completion by Richardson and Company; The Pun Group was instrumental in getting the District ready for the audit and assisted the District through the end of June. The District plans to proceed with in-house resources to prepare for the FY21-22 audit but may use another accounting firm for assistance on limited reconciliations and other audit preparation activities. FY22-23 has ended and we are firmly in FY23-24. Upon completion of the FY21-22 audit, we will proceed to the FY22-23 audit.

EMPLOYEE DEVELOPMENT

CONFERENCES & TRAININGS

The General Manager attended the California Special District Association's Leadership Summit on June 26-27, 2023. In addition to inspiring leadership training, the summit included dozens of vendors who cater to the needs of special districts. These included vendors who provide retirement accounts (457s) with lower fees for employees, banks that provide CalCards that give cash rebates to the District, a variety of investment vehicles for long term reserves, and information technology solutions. We will be exploring some of these vehicles to help save money for the District and for our employees.

Tyler Trainings continue.

EXAMS PASSED

None this month.

OPERATIONS

CHEMICAL USAGE CHANGE

From the 2021 State Budget Act, the District received \$1.3 million in General Fund money to help finance the transition from Chlorine Gas to the less hazardous Liquid Chlorine. The design work for the Water Treatment Plant's conversion was completed and the construction project contract is on today's agenda for consideration. The design work for the Wastewater Treatment Plant's conversion is still in process. A portion of the funding will also be used to improve the safety of the Granlees Dam forebay cover. There is an Agenda Action Item to advance the WTP conversion to the next step.

DEVELOPMENT

RESIDENCES EAST

The District's Engineer has finished the grading and drainage studies for the Residences East and West.

RETREATS NORTH

K Hovnanian Homes has completed the Utility items on the punch list for the North phases of the Retreats development and submitted the required items needed for the District Board to formally accept the infrastructure and start the warranty period for the donated infrastructure. The Resolution approving the acceptance of the utility infrastructure is part of today's Agenda. Once accepted, the infrastructure will be booked as a District asset.

RIVERVIEW

The District provided comments regarding Phase 2 designs for improvements and has not yet received a response from the developer.

SECURITY

FOURTH OF JULY INCIDENT

Hundreds of people participated in the Fourth of July festivities at Rancho Murieta North. RMA had requested additional officers from the sheriff's office months ago for additional security support, but in the end Sacramento County was not able to provide additional officers. The District provided three staff for the Fourth of July event and tried to do what they could given the large crowd and limited number of officers.

District security was on site when illegal fireworks were set off at the Gazebo. Kelly Benitez will include this incident in his report, but at least five individuals received second degree burns as a result of the fireworks. Two of the victims were minors, under five years old. District security worked closely with RMA to investigate the issue and was assisted by members of the community who shared footage, leading to the identification of the responsible party. The matter has been turned over to Metro Fire, which has jurisdiction over items involving illegal fireworks.

OUTREACH & REGIONAL COMMUNICATION

MEETING WITH OTHER RANCHO MURIETA ORGS

On June 28th, the District Board President and General Manager met with the Presidents and General Managers of the Rancho Murieta Association and the Rancho Murieta Country Club to discuss common issues and potential solutions. Security issues discussed included crime, vandalism and graffiti and mitigation measures like more cameras.

FACILITIES UPDATE

BOARD ROOM AIR CONDITIONING

The air conditioning broke in the Board Room in early June. Quotes were solicited and a vendor was chosen and the vendor is working to get the necessary construction permit from the county before proceeding with the replacement of the unit.

TREES AROUND THE DISTRICT BUILDING

The Sacramento Tree Foundation planted over 140 trees on the District campus over a year ago. During the week of June 19th, the Foundation brought a crew of two dozen California Conservation Corps members to evaluate the trees, ensure the irrigation was working and mulch around the trees. All but one tree sapling survived the initial year. The Tree Foundation is exploring the possibility of providing additional trees near the Safety Center to replace the three mature trees that were destroyed during last winter's storm.

These trees will eventually provide much needed shade that will enhance the grounds. The staff appreciates the foresight of former Board Member John Merchant who suggested the idea and made the connection with the Tree Foundation.

PRA UPDATE

Requests for information continue. Hundreds of documents and emails have been requested and the cost to produce these items is significant. I hope to have a full report on the specific requests and the accompanying costs at the September board meeting.

COMMITTEE CHANGES

SECURITY COMMITTEE

Due to workload constraints, the GM recommended to the Security Committee member that the committee meetings be cancelled and scheduled only on an as-needed basis. This recommendation was made because the Security unit gives a full report at each Board meeting and the committee work seemed redundant.

COMMUNICATIONS COMMITTEE

Due to workload constraints, the GM recommended to the Communications Committee members that the committee meetings be canceled for this month and postponed for three to four months thereafter while staff addresses pressing issues. This recommendation was made because I am trying to assess and address many operational issues currently and want to address the communication goals after I get the District on a more solid operational foundation. The usual outlets for sharing information with the public will be maintained during this time: the Pipeline, the website, and the Facebook pages will continue to be populated with information regarding the district's activities.

MEMORANDUM

Date: July 19, 2023
To: Board of Directors
From: Kelly Benitez, Security Supervisor
Subject: Security Update Report for the Month of June

OPERATIONS UPDATES

The Department is currently working on the following projects:

- Currently we have 8 full-time gate officers and 2 part-time gate officers.
- 3 full-time patrol officers 3 vacant positions.
- We had 90 Patrol shifts in June 36 were not covered.
- Toyota Truck awaiting parts for lights and sound system.
- Dash Camera for truck waiting on delivery.

Rancho Murieta Association activity:

We continue to work with the RMA Leadership on a regular basis. Our focus is to improve our level of service and have positive contact with residents. The following list is the current focus of our meetings.

- General non-arch rules enforcement (see Violation Summary Report): continued to attend RMA Compliance meetings.
- Meeting 4th of July, preparation.
- Golf Cart change of policy.

Rancho Murieta Commercial Owners Association activity:

- 50th Anniversary at County Club

Rancho Murieta Association
Violation Item Summary Report -- 2023
(This report includes RMA & CSD issued violations)

Violation Item Summary Report	Jan		Feb		March		April		May		June		July	
	CSD	RMA	CSD	RMA	CSD	RMA	CSD	RMA	CSD	RMA	CSD	RMA	CSD	RMA
Motor vehicle violations:														
Motorcycle														
No drivers license			0	1					1	0	0	1		
Speeding	0	37	16	70	19	47	29	48	25	27	7	9		
Speeding - twice speed limit														
Stop signs	17	7	35	18	11	9	29	1	18	9	9	3		
Bus stop signs														
Use of streets							0	1	1	0				
Parking:														
Driveway parking	0	3			10	16	4	7	0	13				
Guest parking					3	0	2	4	1	4				
Overnight street parking	0	1			2	13	12	4	27	7	18	1		
Unauthorized Vehicle (24 hr pass)			1	0	1	6	0	3	0	1				
Accumulation/dumping of debris			0	2			0	1	0	1				
Boat Usage					1	0	2	0	3	0	3	0		
Barbeques, open fires, bonfires														
Carrying passengers/overloaded cart									0	1				
Clothes lines														
Commercial vehicle lettering	0	1							0	1				
Construction overnight parking														
Park hours / curfew			2	0			1	0			3	0		
Decorative lights														
Discharge of firearm														
Chickens					0	1	0	1	0	3				
Dwelling exterior alterations														
Failure to identify														
Fences, screens & enclosures														
Guest w/o resident in comm areas			1	0					0	1				
Home business activities														
Noxious activities									1	0				
Open garage doors									9	0				
Pets - off leash / teathered / noise	0	1	1	0	0	1	1	0						
Property maintenance			0	4	0	3	0	28	0	22	0	9		
Sign rules					0	1								
Skating in common area														
Sports equip/trampoline/basketball	0	2	0	2	0	6	0	5	0	8	0	5		
Storage of building materials														
Stored vehicles							0	1	0	5	0	2		
Trash containers			0	2	0	3	0	1	0	4				
Use of common areas & facilities	0	2	0	2							0	1		
Vandalism														
Vehicle repair or maintenance														
Interference RMA/RMCS														
Working days & hours														
Total Violations	17	54	56	101	47	106	80	105	86	107	40	31	0	0
Citations written by RMCS		17		56		47		80		86		40		0
Citations written by RMA		54		101		106		105		107		31		0
Total Violations		71		157		153		185		193		71		0

Gate Entries by Type

June 1 - 30, 2023

Pass Type	Guest Count North Gate	Guest Count South Gate	Count by Pass Type
Construction	500	268	768
Guest	6,340	3,005	9,345
Real Estate	95	71	166
Vendor	3,331	1,311	4,642
Country Club (x)	1,176	1	1,177
Special Event	271	4	275
TOTALS	11,713	4,660	16,373

Prior Month Totals: 9,748 4,381 14,129

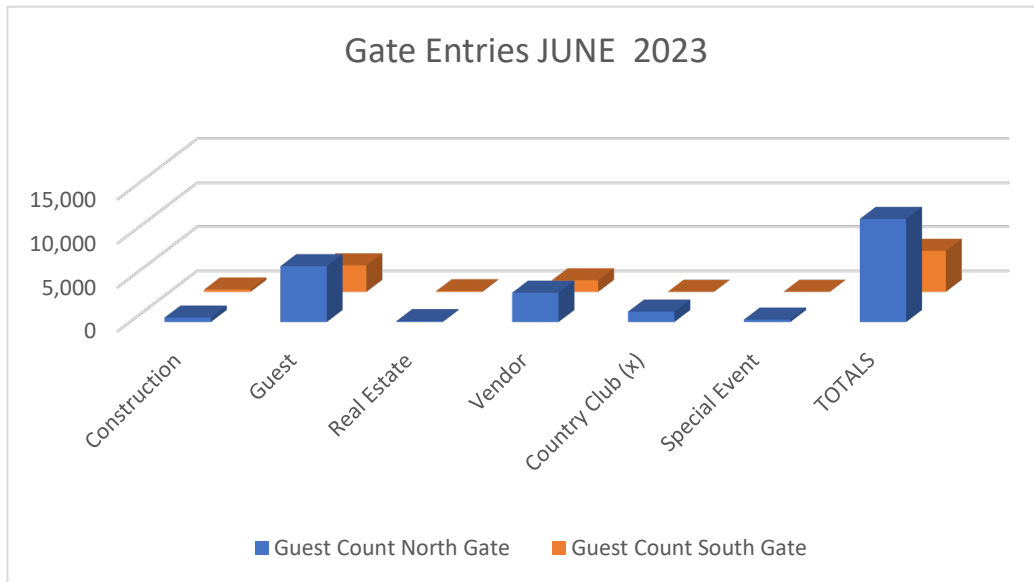

Gate Entries Denied

June 1-30 2023

	Lookers	Resident Refused	Vendor After Hours	No Answer at Resident	Other	Lake/ Park Access	TOTAL
All Gates	3	6	9	5	2	2	27

Prior Month Totals: 6 2 2 6 1 1 18

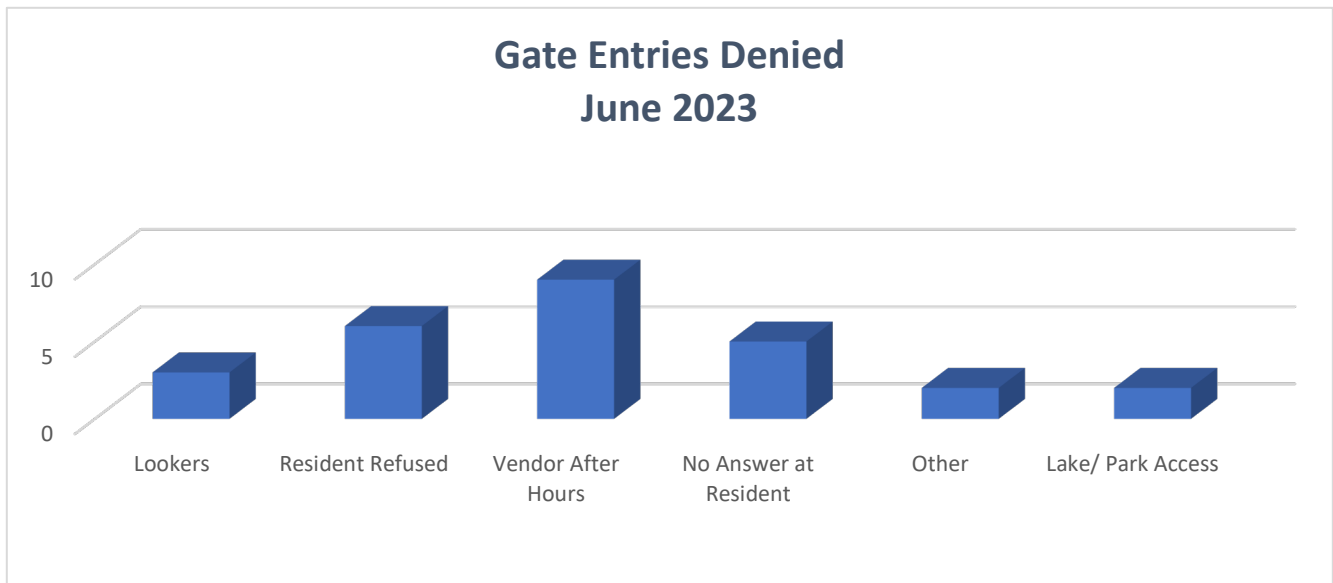



Rancho Murieta CSD Security

15160 Jackson Rd
Rancho Murieta, CA 95662

Cases - Breakdown by Type

ABANDONED DISABLED VEH	1
ALARM	2
ANIMAL COMPLAINT	9
ASSIST OTHER AGENCY	1
BURGLARY	2
CITATION	39
DISTURBANCE	7
ESCORT	4
EXTRA PATROL	38
FOLLOW UP	3
GUN SHOTS	2
INTOXICATED PERSON	2
JUVENILE DELIQUENCY	3
LOST/FOUND PROPERTY	2
MISCELLANEOUS	9
OPEN DOOR	1
PETTY THEFT	1
REFUSED ENTRY	79
RESIDENT COMPLAINT	24
RMA RULE VIOLATION	16
SAFETY ADVISAL	1
SPEEDING COMPLAINT	3
STOLEN/LOST PROPERTY	2
STOLEN/MISSING VEHICLE	1
SUSPICIOUS ACTIVITY	1

SUSPICIOUS PERSON	3
TRAFFIC ENFORCEMENT	14
TRESPASSING	8
VANDALISM	3
VEHICLE ACCIDENT	9
WATER LEAK	10
WELFARE CHECK	8
Total	308



INCIDENTS OF NOTES
June 2023

On 06/13/2023 at 2255 hours, a resident living in the North had driven her vehicle through the visitor lane at the North Gate. The resident had collided her vehicle into the gate officer's personal vehicle, which was legally parked in the parking spot behind the North Gate. The residence then fled the scene without identifying herself. CSD staff were able to retrieve the residence's information via our security camera system. The CHP was contacted, and a report and follow-up investigation was completed. The suspect stated that the reason she didn't stop at the scene of the accident was that she panicked.

On 06/20/2023 at 2300 hours, a resident on Guadalupe Drive contacted 911 to report a burglary in progress (Hot Prowl). The resident was home alone and was taking a shower when she noticed that her dog was barking. The resident walked down the hallway and discovered that an unknown suspect(s) had broken into her residence. The victim ran back to her bedroom and locked the door and called SSD. SSD responded and discovered that the suspects had fled the location. The victim stated that she didn't call CSD because she had heard there was no security at night. CSD was on duty until 0100 hours this evening.

On 06/25/2023 at 1545 hours, CSD was dispatched to a call of a resident brandishing a shotgun at a neighbor during a verbal dispute on Rio Oso. SSD was notified and CSD security set up a perimeter and prevented all traffic from coming into the area. SSD arrived along with an SSD helicopter and three individuals were detained and cited and released by SSD. I spoke with the victim the next day and shared all information with RMA.

06/29/2023 at 0945 hours, RMA personnel observed a juvenile adult driving a golf cart while having an open bottle of an alcoholic beverage in the cart. The suspect attempted to allude the compliance officers and refused to stop their cart. The compliance officer followed the suspect to his residence and made contact and discovered that the underage driver appeared to be under the influence of an alcoholic beverage. CSD was requested to stand by and assist RMA with their investigation. CHP arrived on the scene approximately 60 minutes after being dispatched. CHP arrested the 18 year old for a DUI.

Director of Operations - Utility Staff Report

Date: July 19, 2023
To: Board of Directors
From: Michael Fritschi, Director of Operations
Subject: June Utility Report

WATER

Water Treatment Facility

Plant 1 and Plant 2 are both in operation and are currently producing potable water at a rate of 2.6 million gallons a day.

Water Consumption

As of June 1, 2023, cumulative potable water production for the current year is 199.4 million gallons, with 55.5 million gallons used in the month of June.

Raw Water Storage & Delivery

As of June 30, 2023, Calero and Clementia levels were within the stop log zone. The total water currently stored between Clementia, Chesbro, and Calero totaled 4533.5 acre-ft.

Table 1. Current water and wastewater storage as of the end of June 2023

	acre-ft June 2023	acre-ft full	%full
Clementia Storage	989.6	907.0	109%
Chesbro Storage	993.2	1027.0	97%
Calero Storage	2441.8	2323.3	105%
Total of all Raw Water Reservoirs	4424.6	4257.3	104%
Wastewater Storage Reservoir available for production	354.9	796.3	45%

Figure 1. Five-year Chesbro / Calero Storage Curves

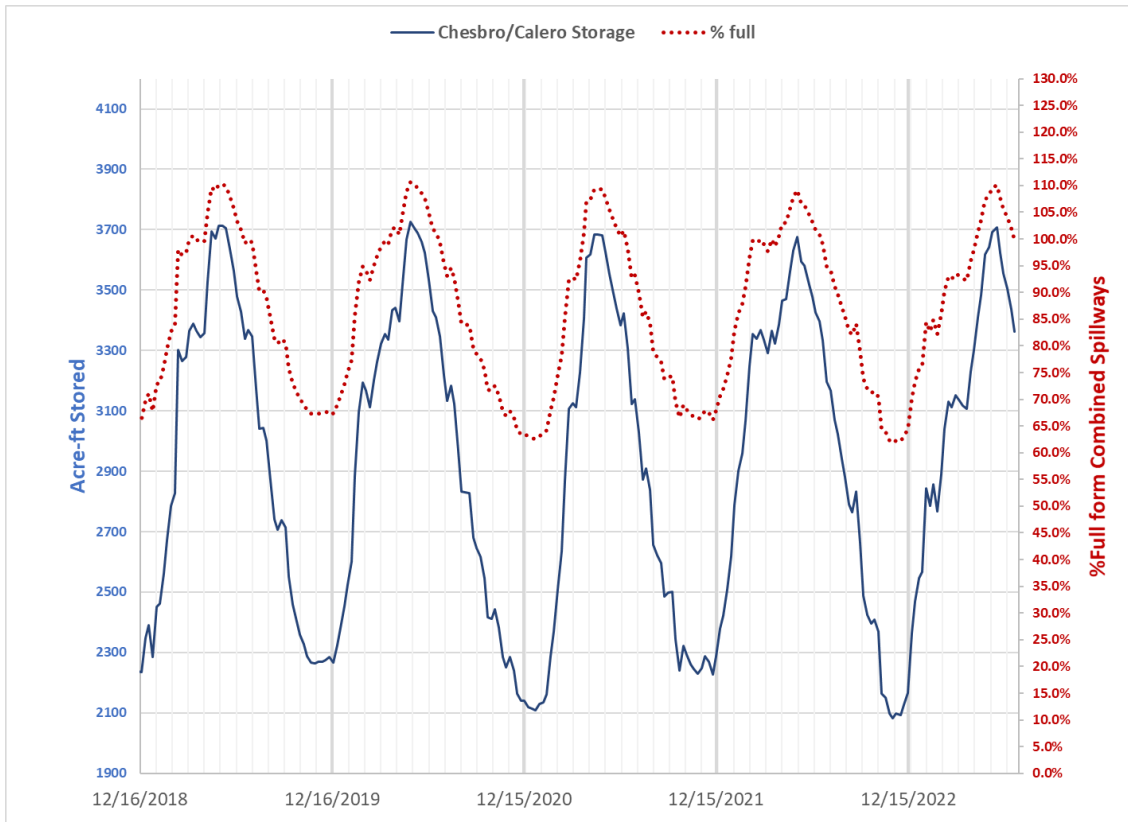
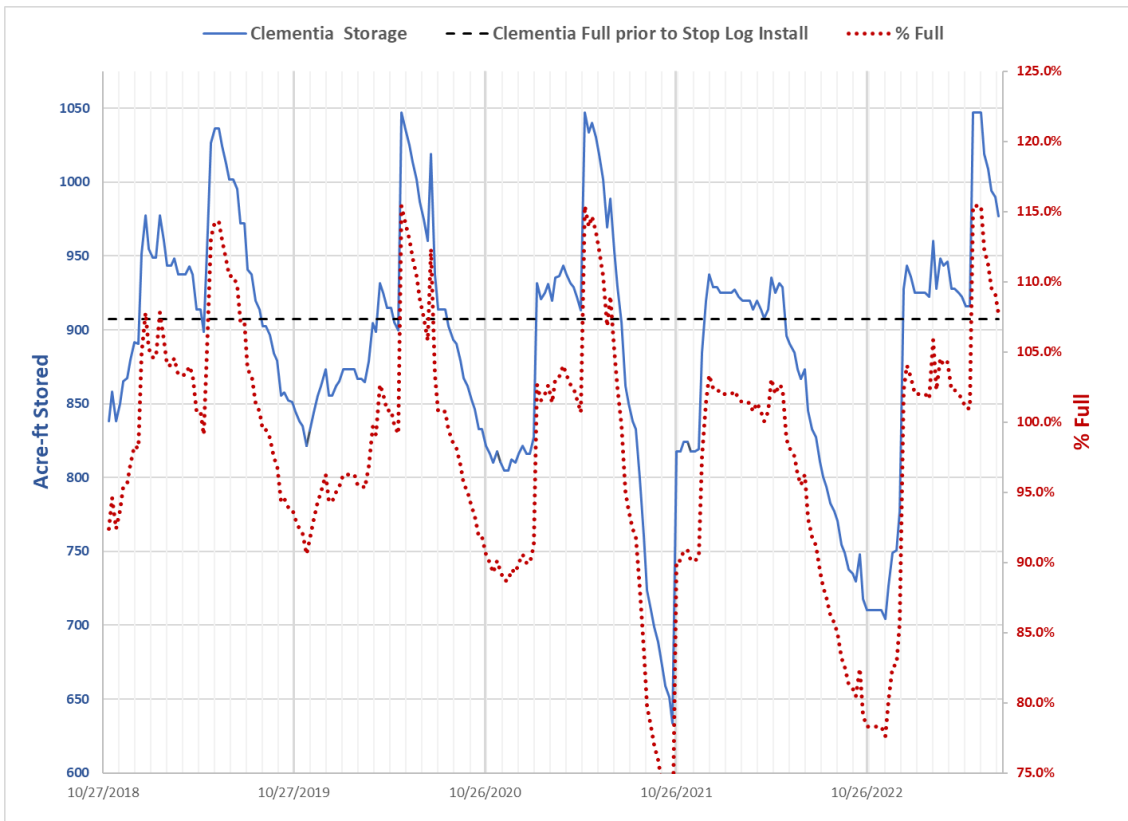

Figure 2. Five-year Clementia Storage Curves



SEWER

Wastewater Facility

The tertiary process of the wastewater facility is currently on-line and producing about 1.8 MGD. The current average dry weather influent to the wastewater facility for June was 0.40 MGD.

The District is working to repair and replace components to the East dissolved air flotation unit.

A replacement control panel has been ordered for the drying bed facility. The drying bed allows onsite generated sludge to be dewatered prior to disposal.

UTILITY CREW WORK

Utility Crew Report June 2023

The District completed (2) utility star work orders. Utility Star work orders are for final readings, rebates, meter swaps requests, issues with homeowner water usage concerns.

Utility staff had 11 field markings for 811 USA locations completed and answered six homeowner calls for water related issues from homeowners with water leaks, wanting water pressure checked and wanting to know why their usage was so high.

Staff responded to (4) water leaks in the month of June, two leaks were excavated, and a temporary repair clamp was installed. Staff will go back in July for a more permanent fix and replace the service lines. The third water leak had the service line replaced along with the serve line next to it. One leak was due to a failed meter gasket which was replaced.

The crew exercised one field valve with 800 gallons of water flushed through the blow-off. No new water meters were installed in June. The crew did spend several days checking water meters from a list generated from the front office that were thought to be bad and found no problems. Staff feel that it there may be something in the programing that is causing the readings to not be picked up.

Utility staff completed 1,242 Ft of sewer main line jetting on Alameda Dr. in response to grease issues in the line. Staff then completed 315 feet of sewer main line video inspection on Alameda Dr. and found that the line had additional grease and would require more jetting, which has been scheduled.

The District is working on trying to schedule the weed removal crew from the California department of corrections to come in and complete a majority of the weed abatement in the drainage areas. The District crew was able to attend to some limited weed abatement in the drainage system in June.

Planned work for July includes replacing water service lines on Camino Del Lago and Pescado Park 2. There are two water leaks in the south at this time planned for repair during the second week of July. The Utility crew will be working on cleaning the Chesbro protection ditch.

CAPITAL PROJECTS

Granlees Safety Project

This project is currently in progress and at the 60% design level.

Water Treatment Facility Chlorine Gas to Sodium Hypochlorite

This project is at the 100% design completion level and the resulting updated opinion of probable construction cost is estimated between \$580,000 to \$670,000. The next step will be to put the project out to bid.

Integrated Water Master Plan

The consultant team has published the initial phase of the story map, which consists of the background information as it relates to water supply. The next steps of the project are to determine water demands and corresponding alternatives to meet those demands. Other supporting work will include hydraulic modeling, infrastructure investigation, and identification of potential capital projects based on alternatives. Ultimately a shared vision model will be the vehicle by which the Integrated Water Master Plan will be updated utilizing the study supply, water demand, and alternatives.

Wastewater Facility Chlorine Gas to Sodium Hypochlorite and Contact Tank Project

The District met with Dewberry & Associates to review chlorine contact tank requirements as provided in the preliminary design technical memorandum. The Engineer will provide some additional investigations and provide the District with an update prior to commencing design of the contact tank.

Lift Stations (No change or update since last month)

Lift 3B - Pumps have been delivered and are ready for installation. The project has been put out to bid and the District expects to receive bids by July 13, 2023.

Alameda & Starter Shack Stations – This project is currently in the design phase.

Cantova & FAA Stations –This project is now in the design phase. The District has requested an easement needed for facility access from the representative of the property bordering Cantova Way.

Lift 6B – KHOV has begun the electrical work at Lift 6B, the updated pumps and equipment have yet to be received by the contractor. The work is expected to be completed by December 2023.

Rancho Murieta Community Services District

August 2023

Board/Committee Meeting Schedule

August 1, 2023

Improvements

8:00 a.m.

Finance

Canceled

August 3, 2023

Communications & Technology

Canceled

Security

Canceled

August 15, 2023

Special Board Meeting - Open Session

2:00 p.m.

August 16, 2023

Regular Board Meeting - Open Session

5:00 p.m.



All meetings will be held in person at the District Office: 15160 Jackson Rd.

From: [Melinda Morris](#)
To: [Beth B](#)
Cc: [Amelia Wilder](#); [Tim Maybee](#); [Randy Jenco](#); [Linda Butler](#); [Martin Pohll](#); [Stephen Booth](#); [Susan Wren](#)
Subject: RE: The Pun Group
Date: Friday, July 7, 2023 5:13:30 PM
Attachments: [image001.png](#)

Good Afternoon, Ms. Buderus:

Thank you for your interest in the administration of the District and in the successful completion of the District's financial audits in particular.

I share your concern that the audits be finalized as quickly as possible.

The Pun Group shared the District's 2020-2021 Fiscal Year documentation with the auditors in late May and the auditors are conducting their work. District staff are in regular communication with the auditors to address issues and make corrections to be able to finalize that audit as soon as possible. Staff is still compiling data regarding infrastructure that resulted from capital improvement projects which needs to be capitalized (recorded as assets) on the District's financial statements. This process may take another two weeks or so. We hope to have the 20-21 audit finalized by the end of August and upon completion of that audit we can begin the 21-22 audit. The 22-23 FY just closed on June 30th and it will be audited upon completion of the 21-22 audit. I believe the 21-22 audit will not take as long as the 21-22 audit and I am hoping that it is completed by January 31st. Similarly, the 22-23 audit should also be produced much more expeditiously – perhaps by June 1, 2024. It is not uncommon for audits to be finalized 9 to 12 months after the FY is closed so at that time we will be back on a more solid footing with regard to the timing of our audits.

Regarding The Pun Group, our contract with The Pun Group is not impacted by Ms. Burke's departure from the accounting firm. The Pun Group contract is still intact and the firm may be called on to assist with a few elements of the 2020-2021 audit. They could, contractually, be asked to assist with the 21-22 audit. However, I recently made the decision that it would be more cost effective to not move forward with the firm for the 2021-2022 audit given the in-house capacity to clean up our financial systems. I, like you, heard the community's concerns at the June 7th meeting regarding the ongoing nature of the audit work and I have my own concerns about the limited resources available to the District. Accordingly, we are planning to manage the 21-22 audit preparation process almost entirely with internal resources and some limited assistance from external consultants on specific reconciliations of items on our books. The District is not planning to contract separately with Ms. Burke.

I am not the best person to comment regarding the origin of the contract with The Pun Group since it predates my arrival, but I can tell you that the invoices paid to date are included in Board meeting materials and are in the range of \$250,000. Finalizing the outstanding audits with internal staff and limited assistance from other external consultants will be a more cost effective approach going forward.

I hope I have answered all your questions, but if I missed anything, feel free to write back and I will

do my best to fully respond to your inquiries.

Best wishes,

Mimi Morris
General Manager
Rancho Murieta Community Services District
mmorris@rmcsd.com
916.354.3708

Rancho Murieta CSD



15160 Jackson Road
P.O. Box 1050
Rancho Murieta, CA 95683

From: Beth B <beth.buderus@gmail.com>
Sent: Friday, July 7, 2023 4:01 PM
To: Melinda Morris <MMorris@rmcsd.com>; Tim Maybee <TMaybee@rmcsd.com>; Randy Jenco <rjenco@rmcsd.com>; Linda Butler <lbutler@rmcsd.com>; Martin Pohll <MPohll@rmcsd.com>; Stephen Booth <sbooth@rmcsd.com>
Cc: Amelia Wilder <awilder@rmcsd.com>
Subject: The Pun Group

Ms. Morris and the Board of Directors:

I would like to receive some clarification on the audit situation. I have read the River Valley Times articles from June 21 and July 5th covering the June 7th and June 21st Board Meeting and I have some concerns.

I heard a rumor a little over 2 weeks ago that the Pun Group was no longer assisting CSD with the financial statements. I also heard that Vanessa Burke was no longer working for the Pun Group. I expected to read about this in the past two weeks of the RVT but there hasn't been any mention of it. Today I got curious and looked up the Pun Group and noticed she is no longer a partner.

So instead of broadcasting this all over social media, I decided to contact you.

I do have some questions for you.

Now that the Pun Group may no longer be working on the financial system, where do we stand on the two overdue audits? And I believe the current year is now due also.

I have read the June 21st RVT article (June 7th Board Meeting coverage) where Ms. Morris stated that she predicted the 2020-21 audit to be completed in the next several months. Is that still accurate? If so, what is your definition of several months, 5 to 7 months?

Also in reading the June 21st RVT, past CSD Director Betty Ferraro criticized the Pun Group for dragging out the process. And Director Booth had also criticized them but then clarified that the consultants couldn't get the data they needed due to the outdated legacy system and staff issues. He had also said he was impressed by the progress Morris and Susan Wren had made.

So at the time of this June 7th Board Meeting, had you already dismissed the Pun Group? If so, why was that not mentioned in the article? Reading the July 5th RVT covering the June 21st Board Meeting, there is also no mention of the audit or the Pun Group.

As for the Pun Group, I assume CSD had a contract with them. How much did CSD pay for their incomplete service? Who recommended this company to CSD?

Finally, is Vanessa Burke separately engaged or working with the CSD any longer?

I would appreciate hearing from you about this matter.

Thank you,
Beth Buderus

MEMORANDUM

Date: July 19, 2023
To: Board of Directors
From: Michael Fritschi, P.E. – Operations Director
Subject: Water Treatment Facility Chlorine Gas to Sodium Hypochlorite Conversion Project

Proposed Action

Staff plan to move forward with the Bid process to obtain construction services for the Water Treatment Facility Chlorine Gas to Sodium Hypochlorite Conversion Project (project).

Background

The District contracted with HDR Engineering to prepare a design to completely replace the existing chlorine gas disinfection system with a Sodium Hypochlorite (NaOCl) disinfection system. The design has reached the 100% level and the District is ready to take the next step in scheduling the project to go out to bid.

The District has received the updated Opinion of Probable Construction Cost (cost opinion) for the project. The estimate is based on the Association for the Advancement of Cost Engineering (AACE) Class 2 cost estimate methodology and ranges from \$580,000 to \$670,000 to complete construction. The estimate includes a 12% contingency and a total of 10% for construction cost escalation and market uncertainty.

The District has budgeted \$700,000 for this project in the current fiscal year which will also need to support construction management and engineering during construction service efforts. A total of \$352,000 was been originally earmarked from SB 170 funding for this project. As of the end of May 2023, \$163,000 out of a contract of \$238,000 has been spent on design efforts.

MEMORANDUM

Date: July 19, 2023
To: Board of Directors
From: Michael Fritschi, P.E. – Operations Director
Subject: Acceptance of Infrastructure for Retreats North

Proposed Action

Staff is requesting that the Board approve Resolution R2023-12 accepting water, sewer and storm utility infrastructure from the Retreats North development and to direct and authorize the General Manager to sign the Bill of Sale that will officially accept the infrastructure from the K. Hovnanian Homes.

Background

1. K. Hovnanian Homes (developer) has requested District acceptance of water, sewer, and drainage infrastructure.
2. Per Policy 2009-04 the Developer shall provide the following prior to the acceptance of infrastructure:

a. Inspection “walk-through” – Completed Punch lists

Staff have verified that the utility infrastructure has been installed per District standards for Retreats North. The District has also received record drawings and associated AutoCAD files.

The Lift Station 6B improvements are scheduled to be completed in December of 2023 and will be accepted as a separate Board action as previously agreed.

b. 1-year warranty bond for 10% of the value of improvements

The Developer has previously filed a subdivision (improvement) bond with Sacramento county that covers all developed assets (including utilities) to a length of (1) year from the time at which Retreats North utility infrastructure are accepted by the District. Prior to the end of the 1-year warranty period, staff will inspect utilities for any deficiencies that may need to be corrected.

Staff have received the value of the infrastructure from the Developer so that the District can bring in the value of the infrastructure as assets for depreciation and as future replacement value.

c. Easements and recorded

Staff have verified that public utility right of way easements have been recorded.

3. Once all the acceptance items are completed, a Resolution will need to be approved by the Board to accept the infrastructure and the General Manager will need to be directed to enter into a Bill of Sale (transfer agreement) with the Developer.

**RANCHO MURIETA COMMUNITY SERVICES DISTRICT
BILL OF SALE
TRANSFERRING UTILITY SYSTEM IMPROVEMENTS**

Property Owner Name and Address	AG EHC II (HOV) CA 2, L.P., a Delaware limited partnership c/o Essential Housing Asset Management LLC 8585 E. Hartford Drive, Suite 118 Scottsdale, AZ 85255
Type and Size of Development Project (include no. of dwelling units or edus)	The Retreats North 52 Single Family Dwellings and 473,371 sf of open space and landscaping.
Development Project Real Property	_____ Co. APN(s): See attached map, Exhibit A
Date of Developer Agreement	June 12, 2015

AG EHC II (HOV) CA 2, L.P., a Delaware limited partnership (“AG”) does hereby grant, transfer, convey and deliver to Rancho Murieta Community Services District (“District”) all of AG’s right, title and interest in and to the District-Owned Improvements as described in the Rancho Murieta Community Services District Extension / Modification of Facilities Agreement Water/Sewer/Drainage for The Retreats North and The Retreats East dated June 12, 2015 Agreement and as shown on the District-approved utility system improvement plans for the District-Owned Improvements on file in the District office. The transfer of the District-Owned Improvements includes all mains, pipelines, meters, hydrants, branching pits, manholes, valves, risers, equipment, apparatus, improvements, and other appurtenances that are part of the District-Owned Improvements. The actual installation cost of the District-Owned Improvements is attached hereto as Exhibit B.

SIGNATURES ON NEXT PAGE

Dated: July 12, 2023

AG

By: Wendy Stoeckel

Wendy Stoeckel *[name]*
Authorized Representative of Essential Housing Asset Management,
LLC, an Arizona limited liability company, Authorized Agent of AG
EHC II (HOV) CA 2, L.P. a Delaware limited partnership *[title]*

Bill of Sale accepted by District:

Dated: _____, 20____

Melinda Morris
General Manager

EXHIBIT A

THE RETREATS NORTH

lot No.	Street Adress	APN
Parcel A		073-0940-063
Parcel B		073-0940-064
Parcel D		073-0940-066
Parcel E		073-0940-067

BAKER WILLIAMS ENGINEERING GROUP
6939 Sunrise Blvd #112
Citrus Heights, CA 95610
916-331-4336

EXHIBIT B

THE RETREATS NORTH - 52 LOTS

June 13, 2023

ACTUAL INSTALLATION COST FOR SEWER, WATER, & DRAIN SYSTEMS

SEWER

ITEM	DESCRIPTION	QUANTITY	UNIT	UNIT PRICE	COST
1	6" VCP Sewer Pipe	914.00	LF	\$ 60.25	\$ 55,068.50
2	48" SSMH	9.00	EA	\$ 6,600.00	\$ 59,400.00
3	60" SSMH	2.00	EA	\$ 6,600.00	\$ 13,200.00
4	Connect to Existing Stub	1.00	EA	\$ 6,000.00	\$ 6,000.00
5	4" Sewer Service w/ Clean Out	19.00	EA	\$ 1,600.00	\$ 30,400.00
	<i>North- Ph. 2</i>				
6	6" VCP Sewer Pipe	1820.00	LF	\$ 60.25	\$ 109,655.00
7	48" SSMH	12.00	EA	\$ 6,600.00	\$ 79,200.00
8	60" SSMH	2.00	EA	\$ 6,600.00	\$ 13,200.00
9	Connect to Existing Stub	1.00	EA	\$ 6,000.00	\$ 6,000.00
10	4" Sewer Service w/ Clean Out	33.00	EA	\$ 1,600.00	\$ 52,800.00
	<i>Sewer Later to Del La Cruz</i>				
11	6" PVC Sewer Main	237.00	LF	\$ 60.25	\$ 14,279.25
12	8" PVC Sewer Main	302.00	LF	\$ 70.00	\$ 21,140.00
13	8" PVC Sewer Main in the Street	80.00	LF	\$ 70.00	\$ 5,600.00
14	Sewer Service	3.00	EA	\$ 1,600.00	\$ 4,800.00
15	Drop Connection	1.00	EA	\$ 6,600.00	\$ 6,600.00
16	Rechannell Manhole	1.00	EA	\$ 6,000.00	\$ 6,000.00
17	Utility Conflict	1.00	LS	\$ 25,332.00	\$ 25,332.00
18	Fuel Increase	1.00	LS	\$ 17,694.00	\$ 17,694.00
19	Material Price Increase	1.00	LS	\$ 15,302.00	\$ 15,302.00
20	Hard Rock Dig	1.00	LS	\$ 112,190.00	\$ 112,190.00
				SUBTOTAL	\$ 653,860.75

DRAIN

ITEM	DESCRIPTION	QUANTITY	UNIT	UNIT PRICE	COST
21	12" Storm Drain Pipe	650.00	LF	\$ 72.30	\$ 46,995.00
22	48" SDMH	7.00	EA	\$ 7,200.00	\$ 50,400.00
23	Flat Slab Manhole	2.00	EA	\$ 6,500.00	\$ 13,000.00
24	Drain Inlet	9.00	EA	\$ 3,750.00	\$ 33,750.00
25	Connect to Existing	2.00	EA	\$ 1,200.00	\$ 2,400.00
	<i>North- Ph. 2</i>				
26	8" Storm Drain Pipe	105.00	LF	\$ 63.00	\$ 6,615.00
27	12" Storm Drain Pipe	1225.00	LF	\$ 72.30	\$ 88,567.50
28	18" Storm Drain Pipe	106.00	LF	\$ 128.00	\$ 13,568.00
29	24" Storm Drain Pipe	412.00	LF	\$ 137.00	\$ 56,444.00
30	Overland Ditch	1180.00	LF	\$ 30.00	\$ 35,400.00
31	48" SDMH	7.00	EA	\$ 7,200.00	\$ 50,400.00
32	Outfall Structure	2.00	EA	\$ 7,500.00	\$ 15,000.00
33	12"x12" Drain Inlet	1.00	EA	\$ 1,800.00	\$ 1,800.00
34	Type F Drain Inlet	3.00	EA	\$ 2,900.00	\$ 8,700.00
35	Type C Drain Inlet	1.00	EA	\$ 2,700.00	\$ 2,700.00
36	Type GO Drain Inlet	1.00	EA	\$ 3,750.00	\$ 3,750.00
37	Add 36" Culvert Rip Rap	1.00	LS	\$ 10,363.00	\$ 10,363.00
38	Fuel Increase	1.00	LS	\$ 17,694.00	\$ 17,694.00
39	Material Price Increase	1.00	LS	\$ 15,302.00	\$ 15,302.00
40	Hard Rock Dig	1.00	LS	\$ 49,051.00	\$ 49,051.00
				SUBTOTAL	\$ 521,899.50

BAKER WILLIAMS ENGINEERING GROUP
6939 Sunrise Blvd #112
Citrus Heights, CA 95610
916-331-4336

WATER

ITEM	DESCRIPTION	QUANTITY	UNIT	UNIT PRICE	COST
41	8"Water (PVC C900 CL 150, Includes: Fittings, Bends, Restrained Joints)	1440.00	LF	\$ 65.70	\$ 94,608.00
42	8" Gate Valve	10.00	EA	\$ 2,300.00	\$ 23,000.00
43	Fire Hydrant Assembly	3.00	EA	\$ 14,000.00	\$ 42,000.00
44	Connect To Existing	1.00	EA	\$ 3,900.00	\$ 3,900.00
45	1" Residential Service w/ Meter Box	19.00	EA	\$ 2,330.00	\$ 44,270.00
46	2" Blow Off Valve	4.00	EA	\$ 2,000.00	\$ 8,000.00
47	1" Air Release Valve	1.00	EA	\$ 4,700.00	\$ 4,700.00
	<i>North- Ph. 2</i>				
48	8"Water (PVC C900 CL 150, Includes: Fittings, Bends, Restrained Joints)	2025.00	LF	\$ 65.70	\$ 133,042.50
49	8" Gate Valve	6.00	EA	\$ 2,300.00	\$ 13,800.00
50	8" Tee	2.00	EA		\$ -
51	2" Blow Off	3.00	EA	\$ 2,000.00	\$ 6,000.00
52	12"Water (PVC C900 CL 150, Includes: Fittings, Bends, Restrained Joints)	1194.00	LF	\$ 99.00	\$ 118,206.00
53	Fire Hydrant Assembly	5.00	EA	\$ 14,000.00	\$ 70,000.00
54	Connect To Existing	1.00	EA	\$ 4,700.00	\$ 4,700.00
55	12" Butterfly valve	7.00	EA	\$ 4,400.00	\$ 30,800.00
56	14" Butterfly valve	2.00	EA	\$ 5,300.00	\$ 10,600.00
57	1" Residential Service w/ Meter Box	33.00	EA	\$ 2,330.00	\$ 76,890.00
58	1.5" Irrigation Service	1.00	EA	\$ 6,200.00	\$ 6,200.00
59	1" Air Release Valve	1.00	EA	\$ 4,700.00	\$ 4,700.00
				SUBTOTAL	\$ 695,416.50

TOTAL CONSTRUCTION COST OF SEWER-WATER-DRAIN SYSTEMS \$ 1,871,176.75

Notes

- 1 The cost shown are intended for valuation purposes only for work associated with the Rancho Murieta Community Services District systems for maintenance of the sewer, water, storm drainage improvements.
- 2 The unit cost shown are from actual contracts between the contractor and developer as provided by the contractor therefore Baker-Williams Engineering Group makes no warranties, either expressed or implied, as to the accuracy of the information.

If you have any questions, please contact Michael Robertson at Baker-Williams Engineering Group at 916-331-4336 ext. 111.

BAKER-WILLIAMS ENGINEERING GROUP

Michael Robertson

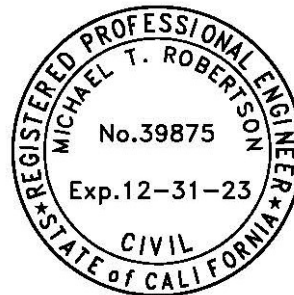

THE RETREATS - NORTH AND EAST

A PORTION OF PARCEL 10, BOOK 117 OF PARCEL MAPS,
PAGE 15, SACRAMENTO COUNTY OFFICIAL RECORDS
AND A PORTION OF PARCEL 6, BOOK 12 OF PARCEL MAPS,
PAGE 47, SACRAMENTO COUNTY OFFICIAL RECORDS,
COUNTY OF SACRAMENTO,
STATE OF CALIFORNIA
BAKER WILLIAMS ENGINEERING GROUP
JANUARY, 2022 SHEET 1 OF 13

OWNER'S STATEMENT:

THE UNDERSIGNED HEREBY CONSENTS TO THE PREPARATION AND RECORDATION OF THIS FINAL MAP.

THE REAL PROPERTY DESCRIBED BELOW IS DEDICATED AS AN EASEMENT FOR PUBLIC PURPOSES.

THE UNDERSIGNED HEREBY OFFERS FOR DEDICATION AND DOES HEREBY DEDICATE TO SPECIFIC PURPOSES:

- A. AN EASEMENT FOR THE PURPOSE OF PUBLIC UTILITIES INCLUDING BUT NOT LIMITED TO WATER, SEWER, GAS AND DRAINAGE PIPES, POLES, OVERHEAD LINES, UNDERGROUND FACILITIES AND OTHER APPURTENANCES AS COUNTY MAY DEEM NECESSARY FOR THE PROPER OPERATION OF SUCH UTILITIES AND FACILITIES SHOWN HEREON AND DESIGNATED PUBLIC UTILITY EASEMENT (P.U.E).
- B. AN EASEMENT FOR CONSTRUCTING AND MAINTAINING CENTRALIZED MAIL DELIVERY FACILITIES INCLUDING BUT NOT LIMITED TO MAILBOXES, MAILBOX STAIRS AND PERTRIAN INCLUDING PEDESTRIAN ACCESS FOR DELIVERY AND RECEIPT OF MAIL ON, OVER, UNDER AND ACROSS STRIPS OF LAND FIVE FEET IN WIDTH, LYING CONTIGUOUS TO THE PRIVATE STREETS SHOWN HEREON.
- C. AN EASEMENT FOR THE PERPETUAL RIGHT OF INGRESS AND EGRESS, INCLUDING VEHICULAR TRAFFIC, AS COUNTY MAY DEEM NECESSARY AND FROM TIME TO TIME FOR THE PURPOSES OF MAINTAINING, IMPROVING, REPAIRING, RECONSTRUCTING AND MAINTAINING COUNTY'S FACILITIES UPON, OVER AND ACROSS THE PROPERTY SHOWN HEREON AND DESIGNATED "INGRESS OR EGRESS EASEMENT" (I.E.E.). THIS EASEMENT INCLUDES THE RIGHT TO IMPROVE THE EASEMENT AREA, AND TO CONSTRUCT, MAINTAIN, REPAIR, RECONSTRUCT AND IMPROVE ANY USE OF THE AREA SUBJECT TO THIS EASEMENT BY THE OWNER WHICH IS NOT COMPATIBLE WITH, OR INTERFERES WITH, THE RIGHTS HEREBY GRANTED SHALL NOT BE ALLOWED, AND IF INSTALLED IN VIOLATION HEREOF, THE SAME SHALL BE REMOVED AT THE PARTY RESPONSIBLE FOR SUCH INSTALLATION OR THE SUCCESSOR THERE TO.
- D. A RIGHT OF WAY AND EASEMENT FOR EMERGENCY ACCESS PURPOSES, TOGETHER WITH THE STRIPS OF LAND SHOWN HEREON AND DESIGNATED "EMERGENCY ACCESS EASEMENT" (E.A.E.).

K. HOVANIANI HOMES NORTHERN CALIFORNIA, INC., A CALIFORNIA CORPORATION

BY: Regina Cantalero
TITLE: Registrar
PRINT NAME: Regina J. Cantalero

NOTARY ACKNOWLEDGEMENT:

A NOTARY PUBLIC OR OTHER OFFICER COMPLETING THIS CERTIFICATE VERIFIES ONLY THE IDENTITY OF THE INDIVIDUAL WHO SIGNED THE DOCUMENT TO WHICH THIS CERTIFICATE IS ATTACHED, AND NOT THE TRUTHFULNESS, ACCURACY, OR VALIDITY OF THAT DOCUMENT.

STATE OF CALIFORNIA
COUNTY OF SACRAMENTO

ON 11/22/2021, 2021, BEFORE ME Stephanie Gonzalez, NOTARY PUBLIC, PERSONALLY APPEARED Regina Cantalero, WHO PROVED TO ME ON BASIS OF SATISFACTORY EVIDENCE TO BE THE PERSON(S) WHOSE NAME(S) IS/ARE SUBSCRIBED TO THE WITHIN INSTRUMENT AND ACKNOWLEDGED TO ME THAT HE/SHE/IT/HEY HITHERTOHER SIGNATURE(S) ON THE INSTRUMENT THE PERSON(S) OR THE ENTITY UPON BEHALF OF WHICH THE PERSON(S) ACTED, EXECUTED THE INSTRUMENT.

I CERTIFY UNDER PENALTY OF PERJURY UNDER THE LAWS OF THE STATE OF CALIFORNIA THAT THE FOREGOING PARAGRAPH IS TRUE AND CORRECT.

WITNESS MY HAND AND OFFICIAL SEAL:
Stephanie Gonzalez
SIGNATURE

MY PRINCIPAL PLACE OF BUSINESS IS Placer COUNTY
MY COMMISSION NO. IS 278898
MY COMMISSION EXPIRES Dec 18, 2025

COUNTY SURVEYOR'S STATEMENT:

I HEREBY STATE THAT I HAVE EXAMINED THIS FINAL MAP OF "THE RETREATS-NORTH AND EAST" AND THAT THE SAME COMPLY WITH ALL PROVISIONS OF THE SUBDIVISION MAP ACT AND ALL APPLICABLE COUNTY ORDINANCES HAVE BEEN COMPLIED WITH AND THAT I AM SATISFIED THAT SAID FINAL MAP IS TECHNICALLY CORRECT.

Jon Hanna
JOHN HANNA, P.L.S., P.E.
SACRAMENTO COUNTY SURVEYOR



DATE: 03-08-2022

BOARD OF SUPERVISORS STATEMENT:

I HEREBY STATE THAT THE BOARD OF SUPERVISORS OF SACRAMENTO COUNTY HAS APPROVED THIS MAP AND HAS ACCEPTED, ON BEHALF OF THE PUBLIC, ALL EASEMENTS AND RIGHTS GRANTED HEREIN AND ALL APPURTENANCES PERTAINING THERE TO SUBJECT TO THE IMPROVEMENT THEREOF.

Shirley Gwalt
CLERK OF THE BOARD OF SUPERVISORS

DATE: 3/22/22

CLERK OF THE BOARD OF SUPERVISORS STATEMENT:

I, FLORENCE EVANS, CLERK OF THE BOARD OF SUPERVISORS OF SACRAMENTO COUNTY, DO HEREBY STATE THAT ALL CERTIFICATES AND SECURITY REQUIRED UNDER THE PROVISIONS OF SECTION 86493 OF THE GOVERNMENT CODE HAVE BEEN FILED AND DEPOSITED WITH ME AND ARE APPROVED BY SACRAMENTO COUNTY.

Florence Evans
CLERK OF THE BOARD OF SUPERVISORS

DATE: 3/22/22

RECORDER'S STATEMENT:

FILED THIS 22nd DAY OF MARCH, 2022, AT 9:16 AM IN BOOK 435 OF MAPS, FOR THE COUNTY OF SACRAMENTO, IN THE OFFICE OF RECORDER OF SACRAMENTO COUNTY. THE LAND INCLUDED IN THIS FINAL MAP BEING VESTED AS PER CERTIFICATE NO. _____ ON FILE IN THIS OFFICE.

FILE NO. 202203130518

BY: Deedra
DEEDRA COUNTY RECORDER

NOTARY ACKNOWLEDGEMENT:

A NOTARY PUBLIC OR OTHER OFFICER COMPLETING THIS CERTIFICATE VERIFIES ONLY THE IDENTITY OF THE INDIVIDUAL WHO SIGNED THE DOCUMENT TO WHICH THIS CERTIFICATE IS ATTACHED, AND NOT THE TRUTHFULNESS, ACCURACY, OR VALIDITY OF THAT DOCUMENT.

STATE OF CA SS

ON 11-19, 2021, BEFORE ME CELINE BLOS, NOTARY PUBLIC, PERSONALLY APPEARED John H. Sullivan, WHO PROVED TO ME ON BASIS OF SATISFACTORY EVIDENCE TO BE THE PERSON(S) WHOSE NAME(S) IS/ARE SUBSCRIBED TO THE WITHIN INSTRUMENT AND ACKNOWLEDGED TO ME THAT HE/SHE/IT/HEY HITHERTOHER SIGNATURE(S) ON THE INSTRUMENT THE PERSON(S) OR THE ENTITY UPON BEHALF OF WHICH THE PERSON(S) ACTED, EXECUTED THE INSTRUMENT.

I CERTIFY UNDER PENALTY OF PERJURY UNDER THE LAWS OF THE STATE OF CALIFORNIA THAT THE FOREGOING PARAGRAPH IS TRUE AND CORRECT.

WITNESS MY HAND AND OFFICIAL SEAL:
Celine Blos
SIGNATURE

MY PRINCIPAL PLACE OF BUSINESS IS Sacramento COUNTY
MY COMMISSION NO. IS 1371456
MY COMMISSION EXPIRES 05-09-2024

SURVEYOR'S STATEMENT:

THIS MAP WAS PREPARED BY ME OR UNDER MY DIRECTION AND IS BASED UPON A FIELD SURVEY IN CONFORMANCE WITH THE REQUIREMENTS OF THE SUBDIVISION MAP ACT AND LOCAL ORDINANCE AT THE REQUEST OF THE THE RETREATS, LLC IN APRIL, 2014. I HEREBY CERTIFY THAT I AM A LICENSED SURVEYOR AND THAT THE POSITIONS INDICATED ON THIS MAP WERE MEASURED AND PLACED IN THE FIELD BY ME OR AN INDICATED ON THIS MAP THAT THEY WILL BE SUFFICIENT TO ENABLE THE SURVEY TO BE RETRACED AND THAT THIS FINAL MAP SUBSTANTIALLY CONFORMS TO THE CONDITIONALLY APPROVED TENTATIVE MAP.

John H. Sullivan
JOHN H. SULLIVAN
MANAGER
TITLE

DATE: 12/18/2021



John H. Sullivan
JOHN H. SULLIVAN
MANAGER
TITLE

DATE: 12/18/2021

THE RETREATS - NORTH AND EAST

A PORTION OF PARCEL 10, BOOK 117 OF PARCEL MAPS,
 PAGE 15, SACRAMENTO COUNTY OFFICIAL RECORDS,
 AND A PORTION OF PARCEL 6, BOOK 12 OF PARCEL MAPS,
 PAGE 47, SACRAMENTO COUNTY OFFICIAL RECORDS,
 COUNTY OF SACRAMENTO,
 STATE OF CALIFORNIA
BAKER WILLIAMS ENGINEERING GROUP
 JANUARY, 2022
 SHEET 2 OF 13

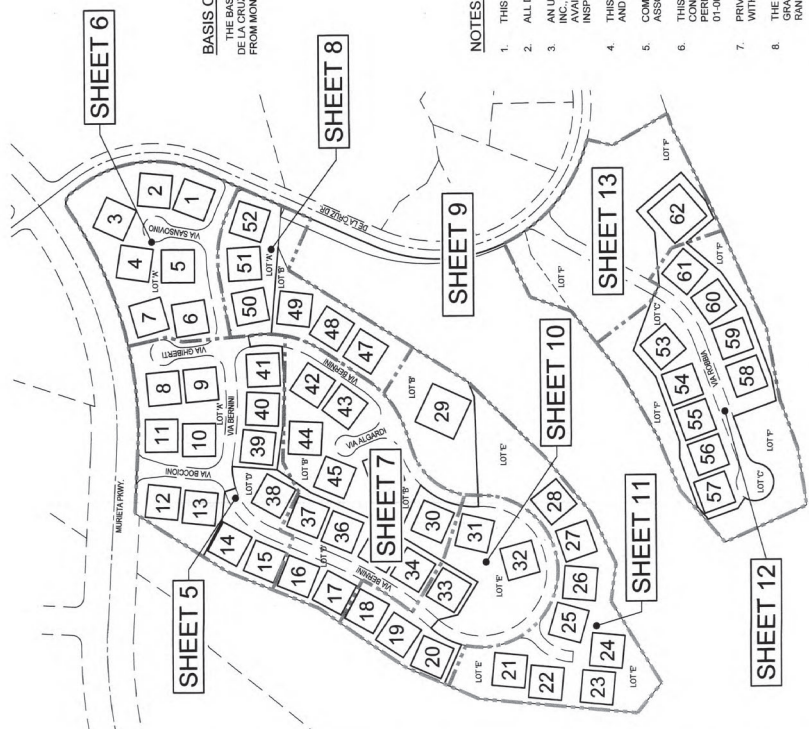

BASIS OF BEARINGS:
 THE BASIS OF BEARINGS FOR THIS SURVEY IS IDENTICAL TO THE CENTERLINE OF
 DE LA CRUZ DRIVE SHOWN ON 213 BM 6 TAKEN AS S 24° 01' 50" W AND ESTABLISHED
 FROM MONUMENTS SHOWN AS FOUND HEREON.

LEGEND:

o	DIMENSION POINT
α	SET 3/4" I.P. W/ 1" BRASS DISC STAMPED "LS 7820"
χ	SET 1-1/4" I.P. W/ ALUMINUM CAP STAMPED "LS 7820"
L	SET 5/8" REBAR W/ ALUMINUM CAP STAMPED "LS 7820" REBAR AT EACH LOT CORNER
⊙	SET 2-1/2" BRASS DISC IN STD. CAL TRANS MONUMENT WELL NO. A74, TYPE D, ALT. 1 OR FOUND AS SHOWN
✳	FOUND MONUMENT AS NOTED. WE SHALL SECURE A WASHER STAMPED "LS 7820" ON THESE MONUMENTS SHOWN AS FOUND HEREON THAT ARE UNTAGGED
P.U.E.	PUBLIC UTILITY EASEMENT
P.U.P.F.E.	PUBLIC UTILITIES AND PUBLIC FACILITIES EASEMENT
I.P.	IRON PIPE
C.I.P.	CAPPED IRON PIPE
O.I.P.	OPEN IRON PIPE
⊕	CENTERLINE
S.E.	SEWER EASEMENT
W.E.	WATER EASEMENT
BM	BOOK OF MAPS
PM	PARCEL MAP
IND	FOUND
E.A.E.	EMERGENCY ACCESS EASEMENT
I.A.E.	INGRESS - EGRESS EASEMENT
ESMT	EASEMENT
PVT	PRIVATE
BC	BEGINNING OF CURVE
PRC	POINT OF REVERSE CURVE
(R)	RADIAL BEARING
O.R.	OFFICIAL RECORDS
(1)	RECORD PER 20051012 O.R. 3017
(2)	RECORD PER 117 PM 15
(3)	RECORD PER 213 BM 6
(4)	RECORD PER 121 BM 8

NOTES:

- THIS SUBDIVISION CONTAINS 23.372 GROSS ACRES MORE OR LESS.
- ALL DIMENSIONS ALONG CURVED LINES ARE ARC DISTANCES.
- AN UPDATED SOILS REPORT WAS PREPARED BY YOUNGDAHL CONSULTING GROUP, INC., DATED APRIL 20, 2014 (PROJECT NO. E02202.001). A COPY OF THIS REPORT IS AVAILABLE FOR PUBLIC INSPECTION AT THE COUNTY OF SACRAMENTO BUILDING INSPECTION DEPARTMENT.
- THIS SUBDIVISION CONSISTS OF 62 SINGLE FAMILY LOTS NUMBERED LOTS 1 THRU 62, AND 6 COMMON LOTS LABELED "A" THRU "F", INCLUSIVE.
- COMMON LOTS "A" THRU "F" SHALL BE OWNED AND MAINTAINED BY THE HOMEOWNERS ASSOCIATION.
- THIS PROPERTY IS SUBJECT TO ANY CONDITIONS OF APPROVAL SET FORTH IN CONNECTION WITH THE ADOPTED TENTATIVE MAP WHICH HAVE NOT BEEN PERFORMED AT THE TIME OF THE FINAL MAP RECORDATION (CONTROL NUMBER 01-0070)
- PRIVATE ACCESS EASEMENTS FOR ACCESS TO EACH PARCEL ARE TO BE PROVIDED WITH THE SALE OF EACH PARCEL.
- THE GRANT OF EASEMENTS AGREEMENT RECORDED IN BOOK 20040624, PAGE 1250 GRANTED ACCESS TO THIS PROPERTY ACROSS ALL PRIVATE ROADS WITHIN THE RANCHO MURIETA COMMUNITY.
- AVIGATION AND NOISE EASEMENT RECORDED IN BOOK 20150303, AT PAGE 0719, AFFECTS THIS PROPERTY.

KEYMAP
 SCALE 1"=300'

THE RETREATS - NORTH AND EAST

A PORTION OF PARCEL 10, BOOK 117 OF PARCEL MAPS,
 PAGE 15, SACRAMENTO COUNTY OFFICIAL RECORDS
 AND A PORTION OF PARCEL 6, BOOK 12 OF PARCEL MAPS,
 PAGE 47, SACRAMENTO COUNTY OFFICIAL RECORDS,
 COUNTY OF SACRAMENTO,
 STATE OF CALIFORNIA
BAKER WILLIAMS ENGINEERING GROUP
 JANUARY, 2022

SHEET 3 OF 13

SCALE: 1" = 20'

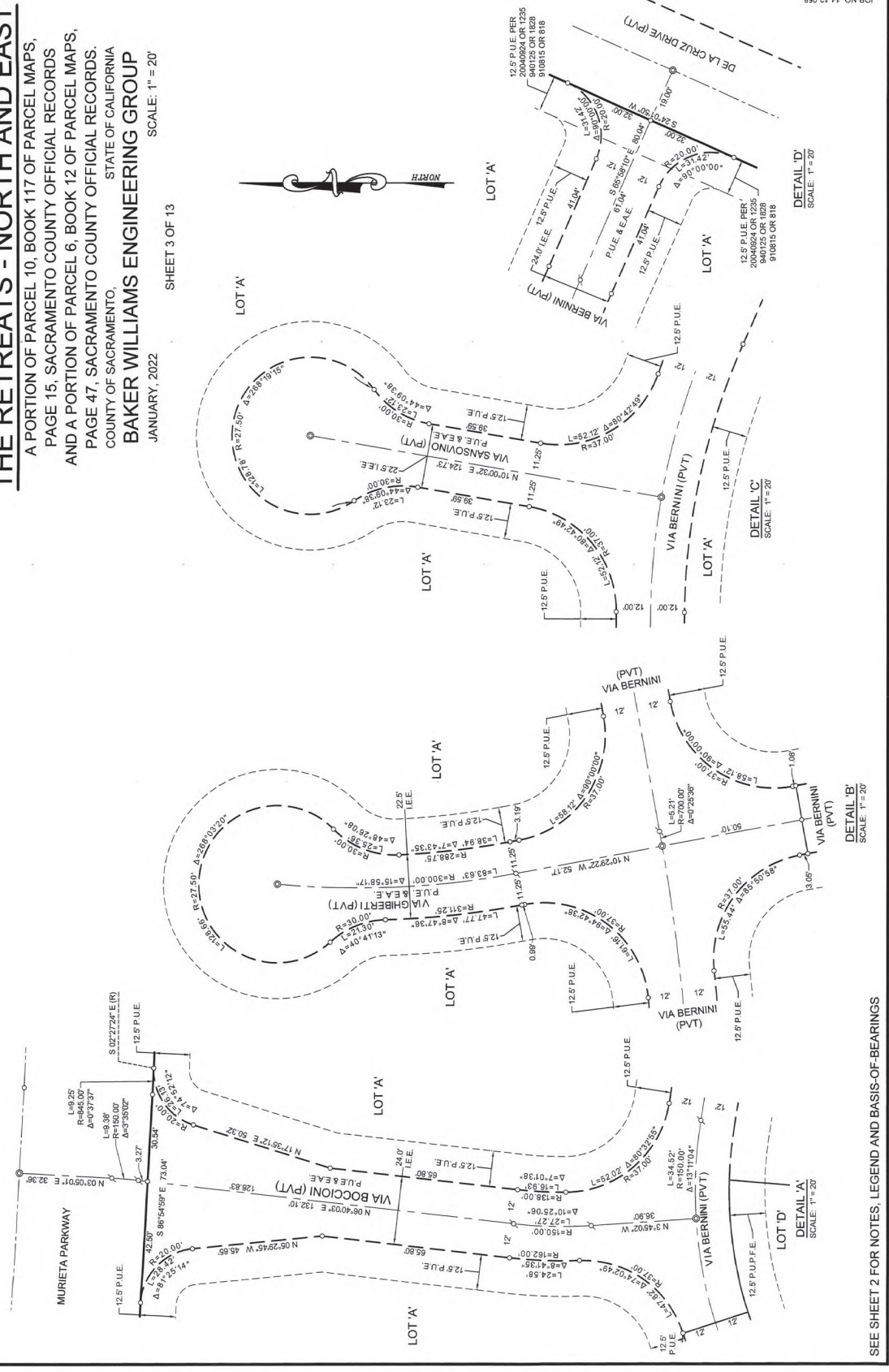

SEE SHEET 2 FOR NOTES, LEGEND AND BASIS-OF-BEARINGS

JOB 14-12-08

THE RETREATS - NORTH AND EAST

A PORTION OF PARCEL 10, BOOK 117 OF PARCEL MAPS,
 PAGE 15, SACRAMENTO COUNTY OFFICIAL RECORDS
 AND A PORTION OF PARCEL 6, BOOK 12 OF PARCEL MAPS,
 PAGE 47, SACRAMENTO COUNTY OFFICIAL RECORDS,
 COUNTY OF SACRAMENTO, STATE OF CALIFORNIA
BAKER WILLIAMS ENGINEERING GROUP
 JANUARY, 2022 SCALE: 1" = 20'

SHEET 4 OF 13

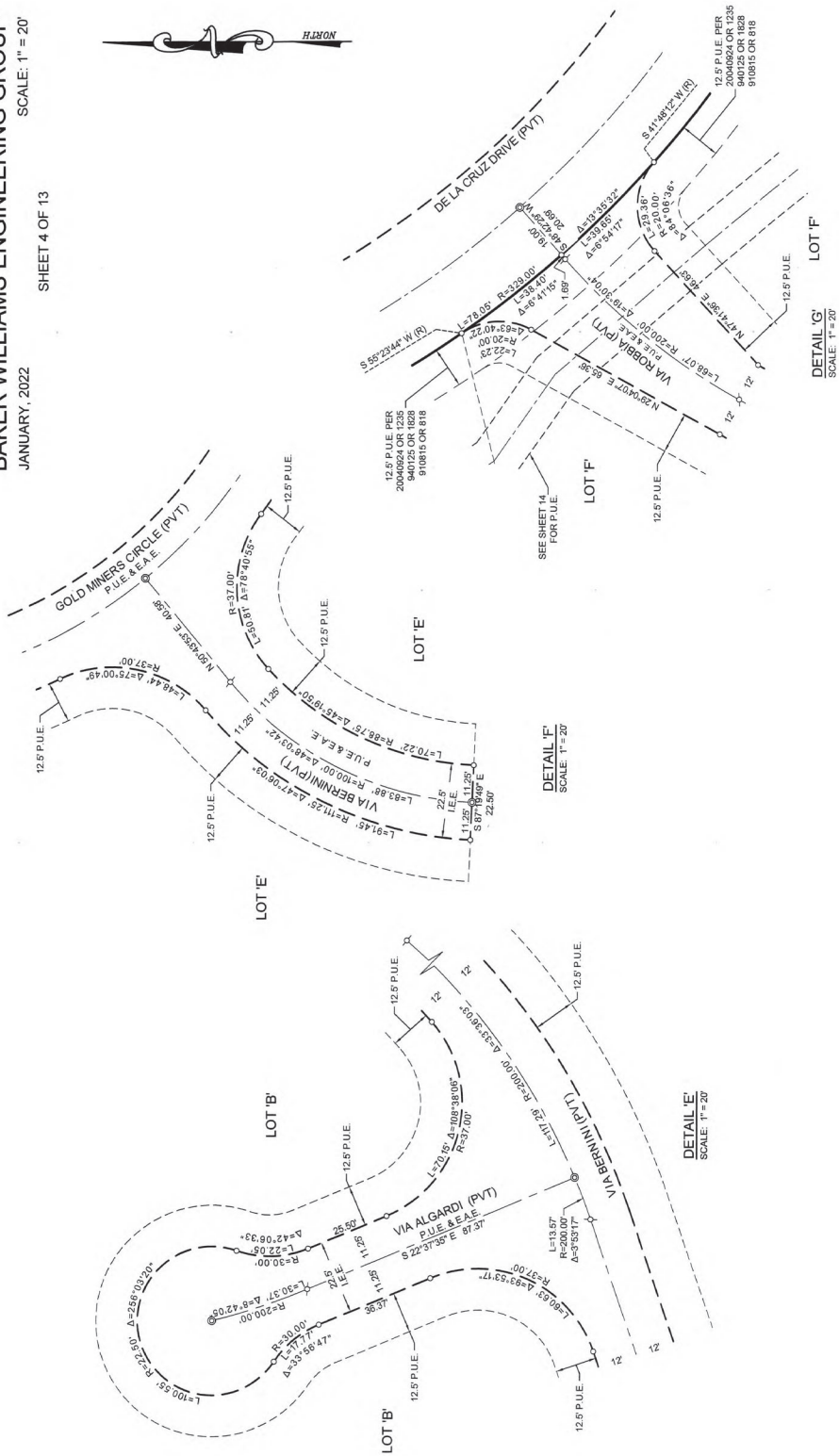

SEE SHEET 2 FOR NOTES, LEGEND AND BASIS-OF-BEARINGS

THE RETREATS - NORTH AND EAST

A PORTION OF PARCEL 10, BOOK 117 OF PARCEL MAPS,
 PAGE 15, SACRAMENTO COUNTY OFFICIAL RECORDS,
 AND A PORTION OF PARCEL 6, BOOK 12 OF PARCEL MAPS,
 PAGE 47, SACRAMENTO COUNTY OFFICIAL RECORDS,
 COUNTY OF SACRAMENTO,
 STATE OF CALIFORNIA
BAKER WILLIAMS ENGINEERING GROUP
 JANUARY, 2022

SCALE: 1" = 30'

SHEET 5 OF 13

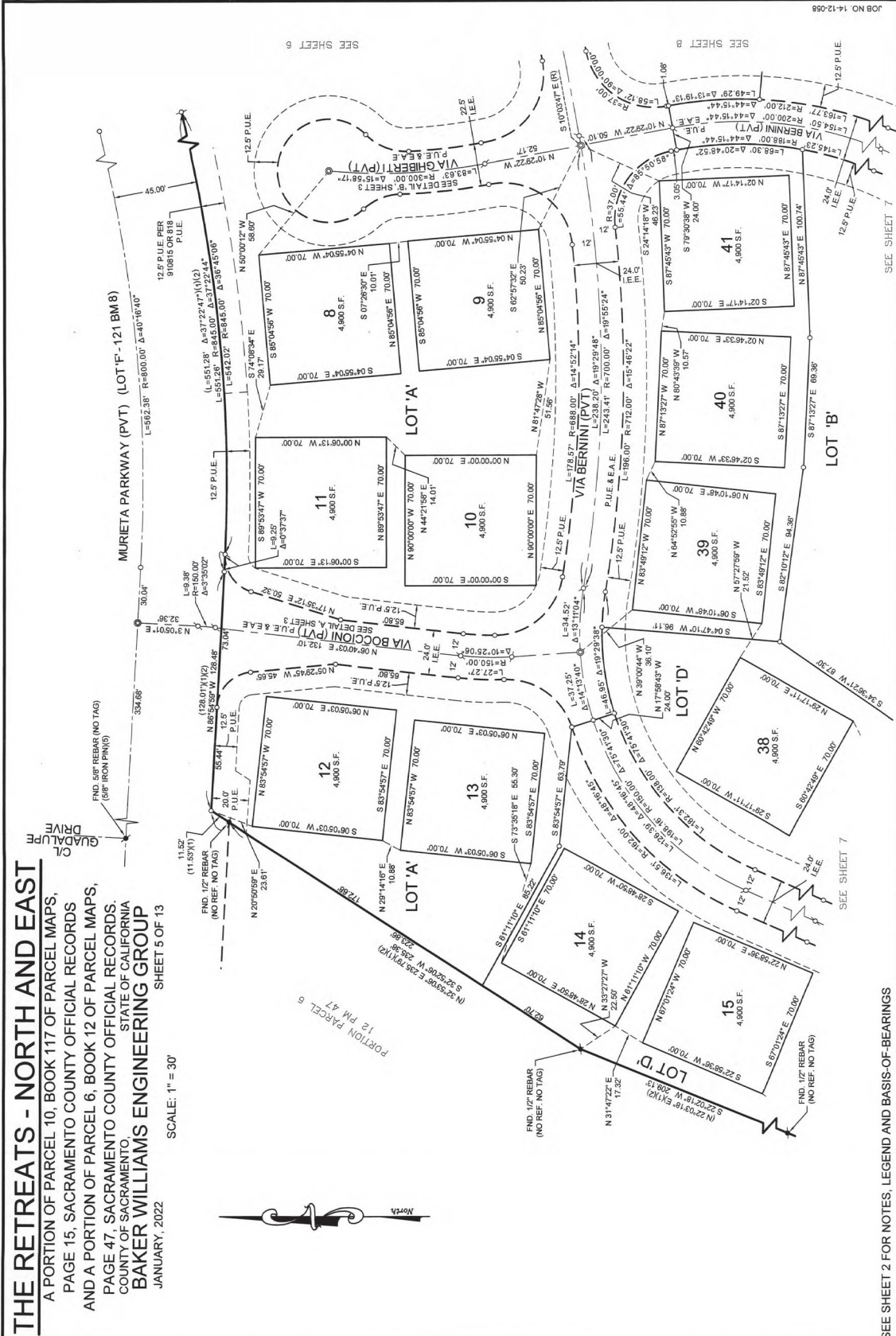

SEE SHEET 2 FOR NOTES, LEGEND AND BASIS-OF-BEARINGS

SEE SHEET 7

SEE SHEET 6

SEE SHEET 8

JOB NO. 14-12-058

THE RETREATS - NORTH AND EAST

A PORTION OF PARCEL 10, BOOK 117 OF PARCEL MAPS,
 PAGE 15, SACRAMENTO COUNTY OFFICIAL RECORDS,
 AND A PORTION OF PARCEL 6, BOOK 12 OF PARCEL MAPS,
 PAGE 47, SACRAMENTO COUNTY OFFICIAL RECORDS,
 COUNTY OF SACRAMENTO,
 STATE OF CALIFORNIA

BAKER WILLIAMS ENGINEERING GROUP
 JANUARY, 2022

SHEET 6 OF 13

SCALE: 1" = 30'

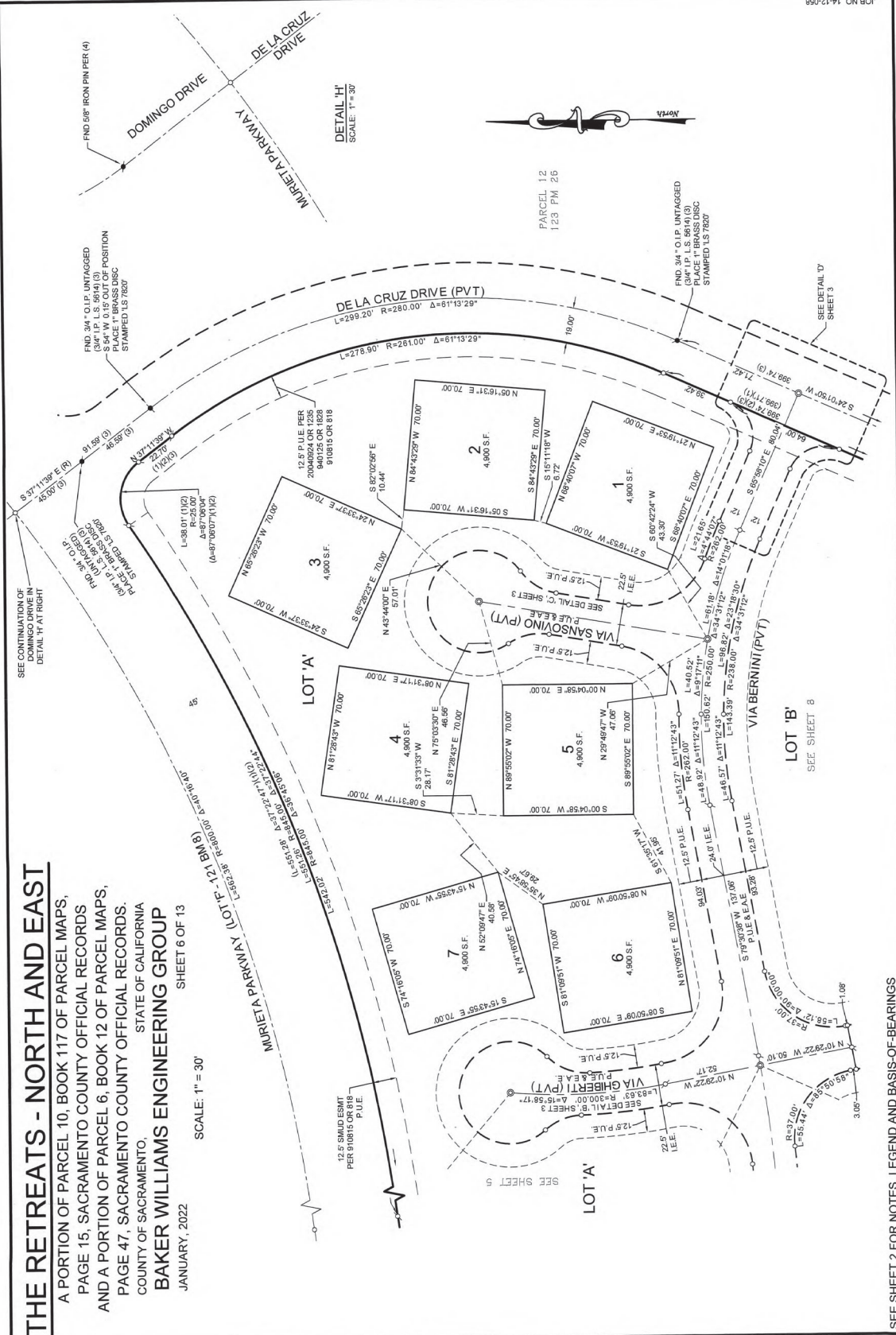

SEE SHEET 2 FOR NOTES, LEGEND AND BASIS-OF-BEARINGS

THE RETREATS - NORTH AND EAST

A PORTION OF PARCEL 10, BOOK 117 OF PARCEL MAPS,
 PAGE 15, SACRAMENTO COUNTY OFFICIAL RECORDS
 AND A PORTION OF PARCEL 6, BOOK 12 OF PARCEL MAPS,
 PAGE 47, SACRAMENTO COUNTY OFFICIAL RECORDS.
 STATE OF CALIFORNIA
BAKER WILLIAMS ENGINEERING GROUP
 JANUARY, 2022
 SHEET 7 OF 13

SCALE: 1"=30'

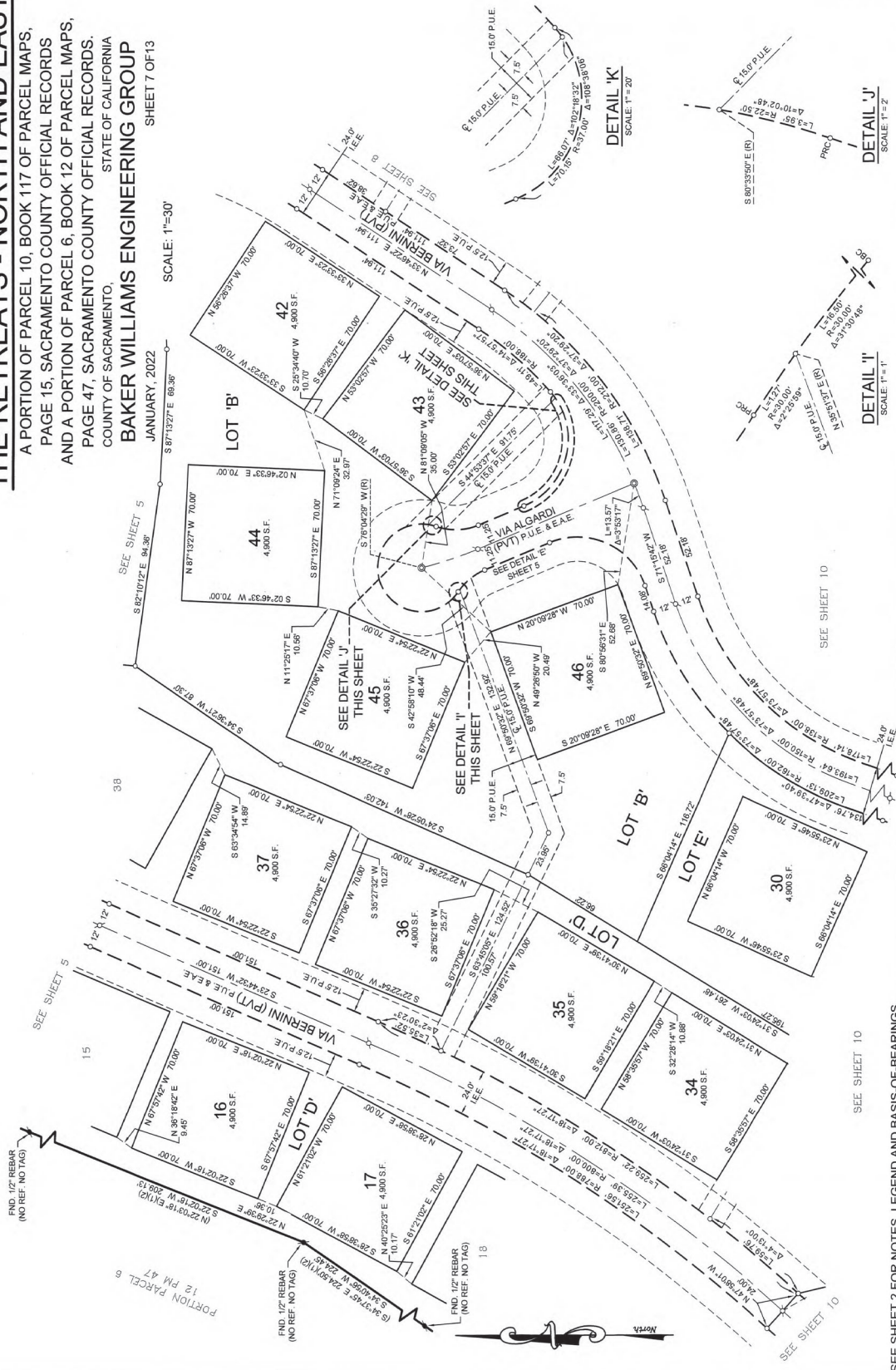

JOB NO. 14-12-058

SEE SHEET 2 FOR NOTES, LEGEND AND BASIS-OF-BEARINGS

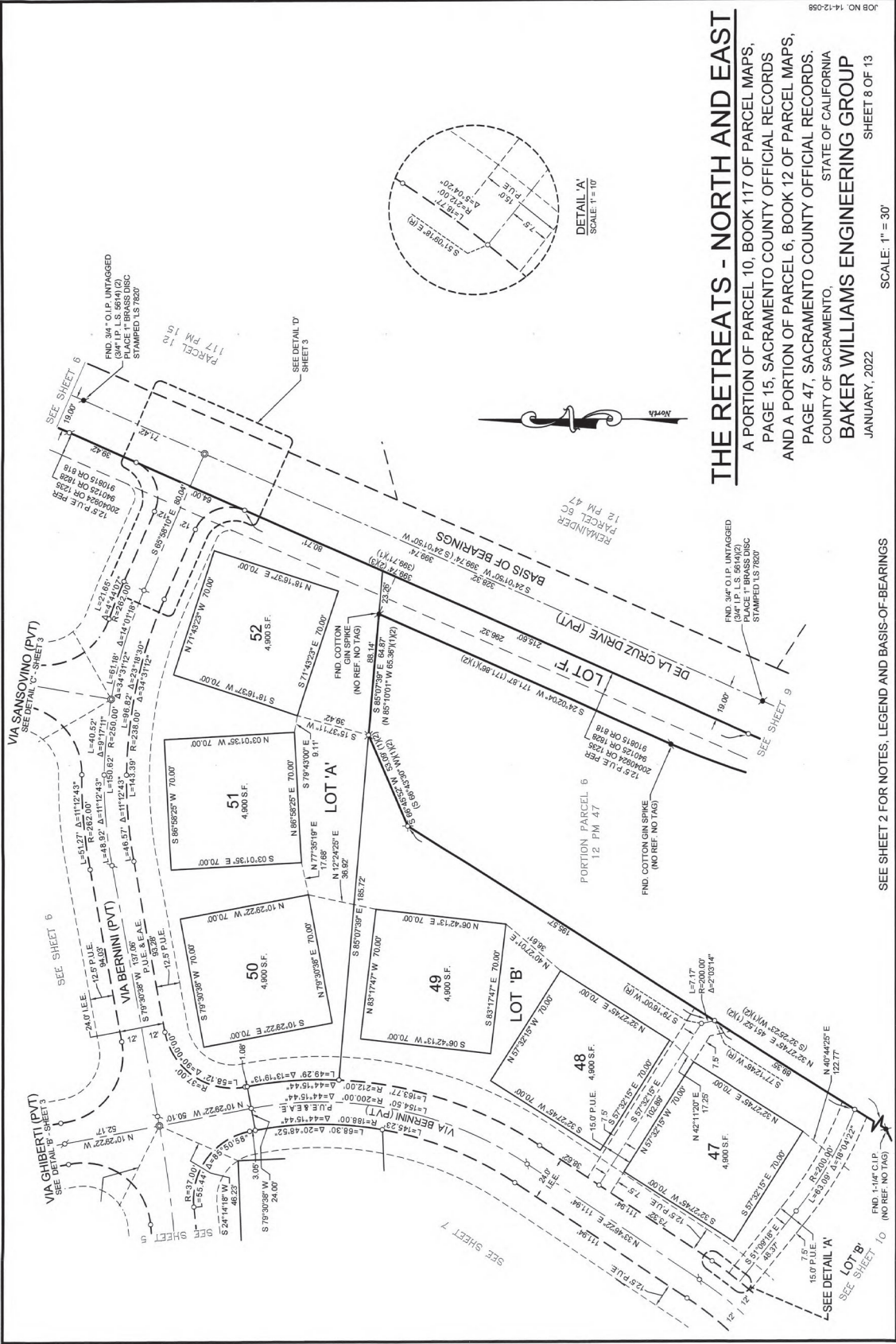

THE RETREATS - NORTH AND EAST
 A PORTION OF PARCEL 10, BOOK 117 OF PARCEL MAPS,
 PAGE 15, SACRAMENTO COUNTY OFFICIAL RECORDS,
 AND A PORTION OF PARCEL 6, BOOK 12 OF PARCEL MAPS,
 COUNTY OF SACRAMENTO, STATE OF CALIFORNIA
BAKER WILLIAMS ENGINEERING GROUP
 JANUARY, 2022

SCALE: 1" = 30'
 SHEET 8 OF 13

SEE SHEET 2 FOR NOTES, LEGEND AND BASIS-OF-BEARINGS

FND. 1-1/4\" C.I.P. (NO REF. NO TAG)

DETAIL 'A'
 SCALE: 1" = 10'



JOB NO. 14-12-058

THE RETREATS - NORTH AND EAST

A PORTION OF PARCEL 10, BOOK 117 OF PARCEL MAPS,
 PAGE 15, SACRAMENTO COUNTY OFFICIAL RECORDS
 AND A PORTION OF PARCEL 6, BOOK 12 OF PARCEL MAPS,
 PAGE 47, SACRAMENTO COUNTY OFFICIAL RECORDS,
 COUNTY OF SACRAMENTO,
 STATE OF CALIFORNIA
BAKER WILLIAMS ENGINEERING GROUP
 JANUARY, 2022 SHEET 9 OF 13

SCALE: 1" = 30'

JOB NO. 14-12-058

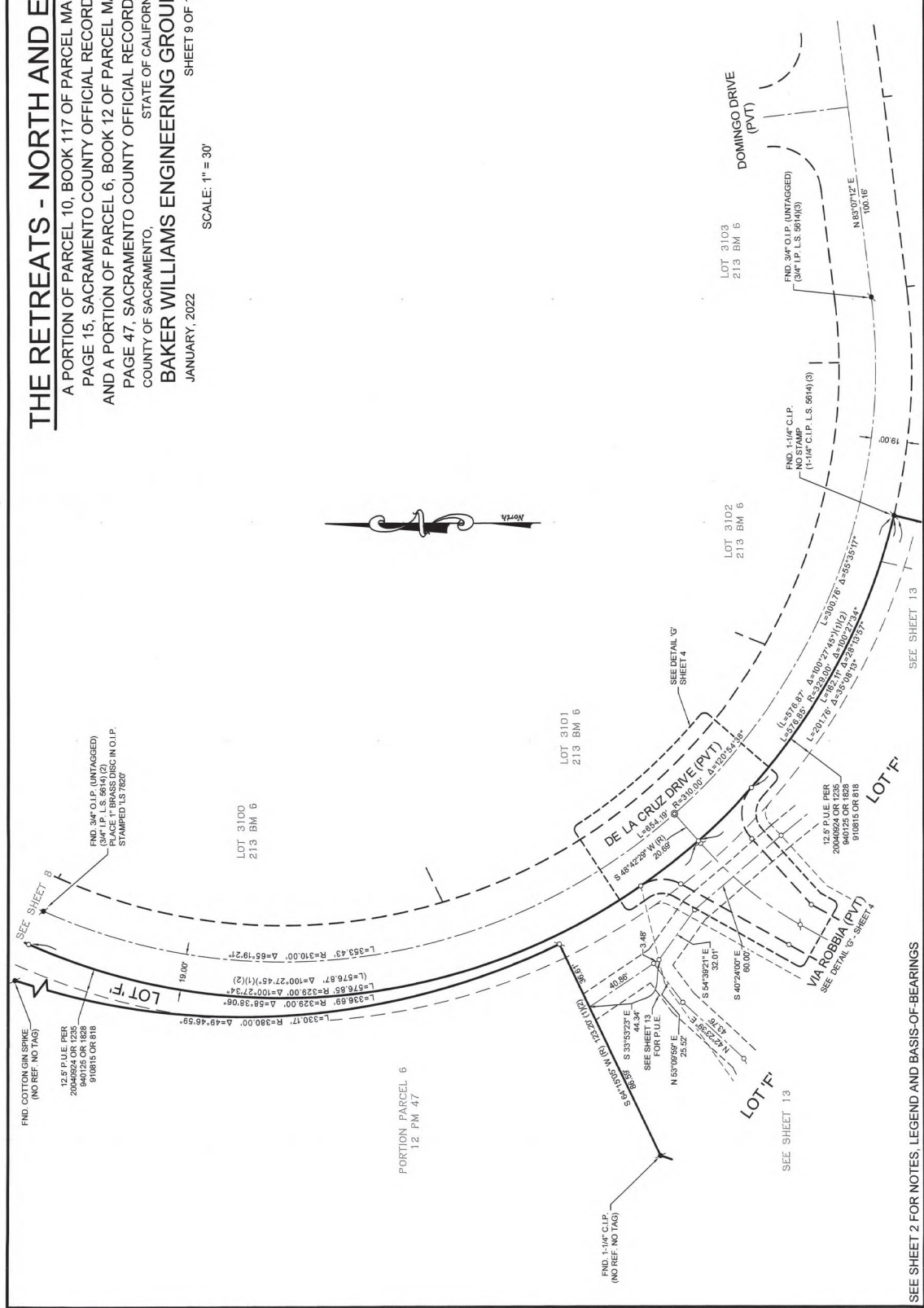

SEE SHEET 2 FOR NOTES, LEGEND AND BASIS-OF-BEARINGS

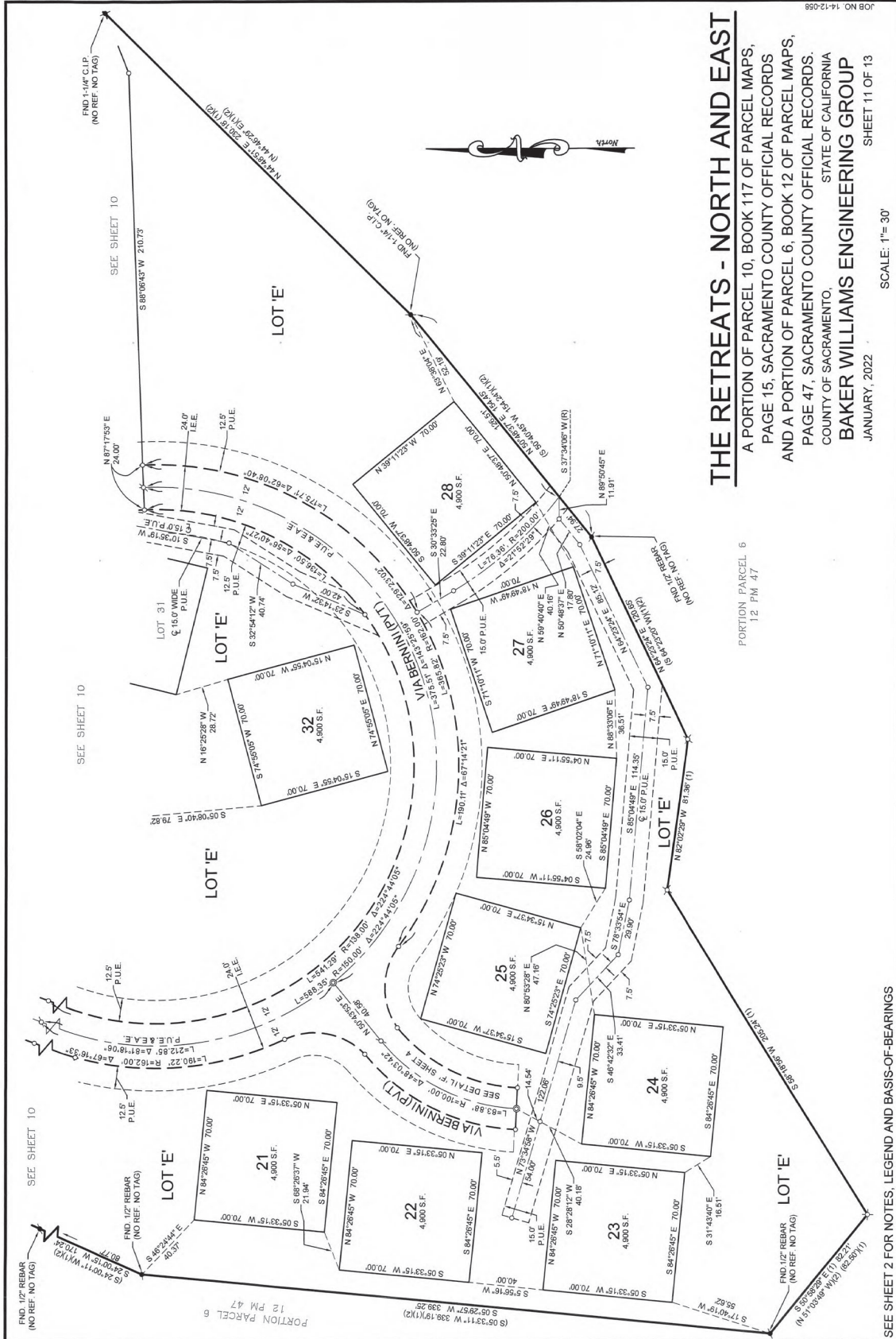

SEE SHEET 10

SEE SHEET 10

SEE SHEET 10

PORTION PARCEL 6
12 PM 47

PORTION PARCEL 6
12 PM 47

THE RETREATS - NORTH AND EAST

A PORTION OF PARCEL 10, BOOK 117 OF PARCEL MAPS,

PAGE 15, SACRAMENTO COUNTY OFFICIAL RECORDS

AND A PORTION OF PARCEL 6, BOOK 12 OF PARCEL MAPS,

PAGE 47, SACRAMENTO COUNTY OFFICIAL RECORDS,

COUNTY OF SACRAMENTO, STATE OF CALIFORNIA

BAKER WILLIAMS ENGINEERING GROUP

JANUARY, 2022 SHEET 11 OF 13

SCALE: 1"= 30'

SEE SHEET 2 FOR NOTES, LEGEND AND BASIS-OF-BEARINGS

800-21-14-12-008 JOB NO

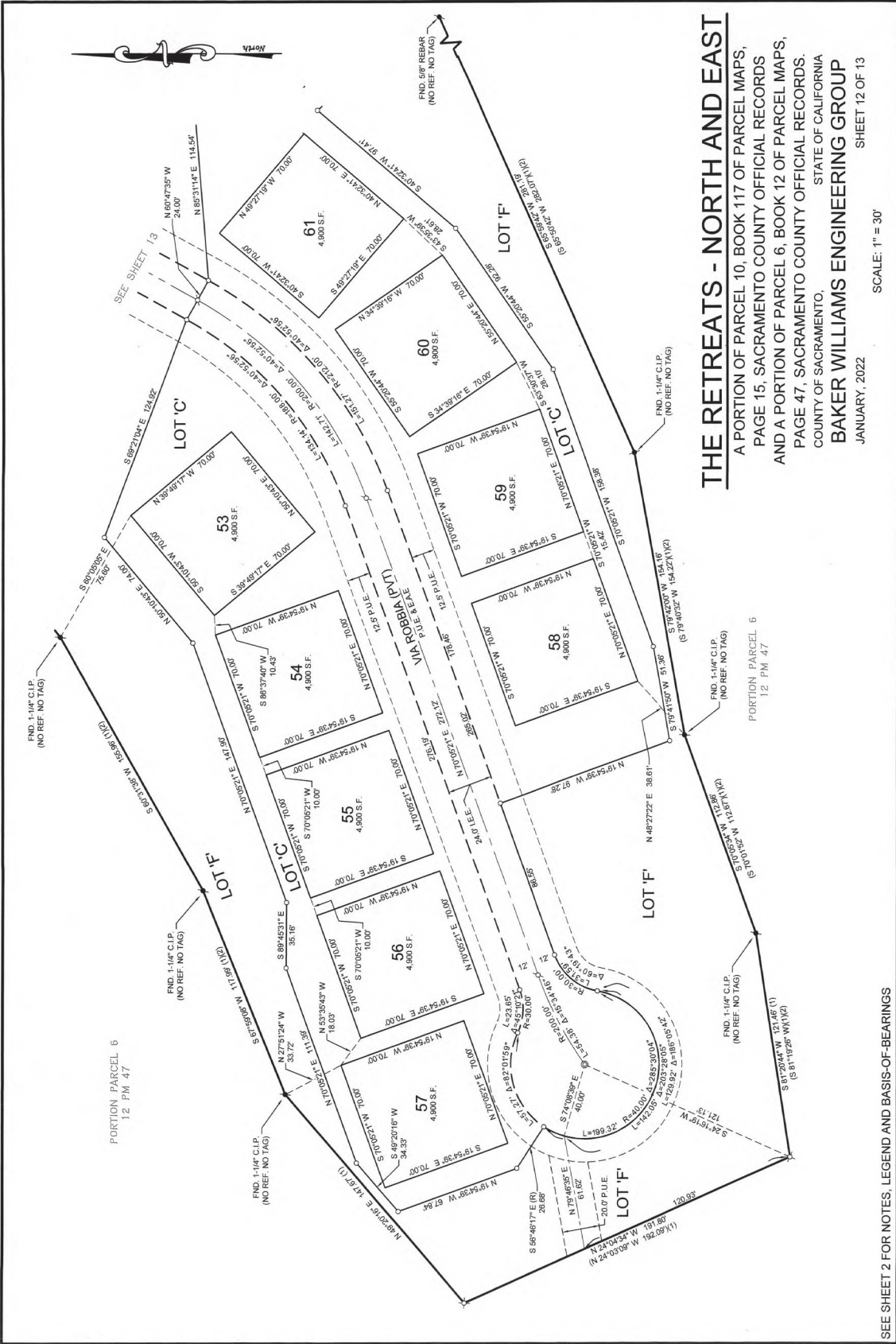

THE RETREATS - NORTH AND EAST

A PORTION OF PARCEL 10, BOOK 117 OF PARCEL MAPS,
 PAGE 15, SACRAMENTO COUNTY OFFICIAL RECORDS
 AND A PORTION OF PARCEL 6, BOOK 12 OF PARCEL MAPS,
 PAGE 47, SACRAMENTO COUNTY OFFICIAL RECORDS,
 COUNTY OF SACRAMENTO, STATE OF CALIFORNIA
BAKER WILLIAMS ENGINEERING GROUP
 JANUARY, 2022

SHEET 12 OF 13

SCALE: 1" = 30'

SEE SHEET 2 FOR NOTES, LEGEND AND BASIS-OF-BEARINGS

THE RETREATS - NORTH AND EAST

A PORTION OF PARCEL 10, BOOK 117 OF PARCEL MAPS,
PAGE 15, SACRAMENTO COUNTY OFFICIAL RECORDS
AND A PORTION OF PARCEL 6, BOOK 12 OF PARCEL MAPS,
PAGE 47, SACRAMENTO COUNTY OFFICIAL RECORDS,
COUNTY OF SACRAMENTO, STATE OF CALIFORNIA
BAKER WILLIAMS ENGINEERING GROUP
JANUARY, 2022

SCALE: 1" = 30'

SHEET 13 OF 13

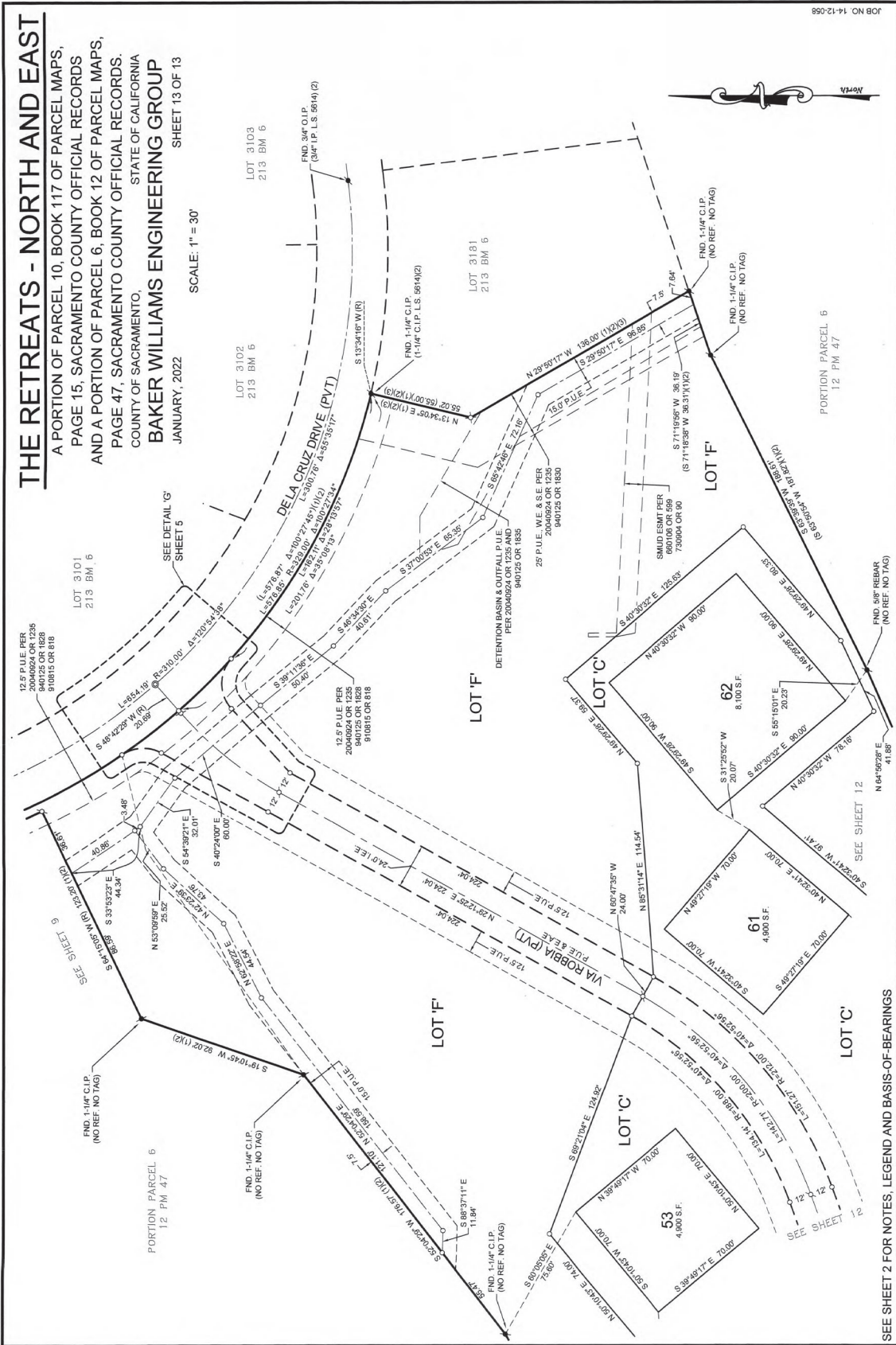

JOB NO. 14-12-056



SEE SHEET 2 FOR NOTES, LEGEND AND BASIS-OF-BEARINGS

PORTION PARCEL 6
12. PM 47

SEE SHEET 12

SEE DETAIL 'G'
SHEET 5

LOT 3101
213 BM 6

LOT 3102
213 BM 6

LOT 3103
213 BM 6

LOT 'F'

LOT 'F'

LOT 'C'

LOT 'F'

LOT 'C'

LOT 'C'

PORTION PARCEL 6
12. PM 47

SEE SHEET 12

RESOLUTION NO. R2023-12

**A RESOLUTION OF THE BOARD OF DIRECTORS
OF THE RANCHO MURIETA COMMUNITY SERVICES DISTRICT
ACCEPTING COMPLETED UTILITY SYSTEM IMPROVEMENTS**

Property Owner Name and Address	AG EHC II (HOV) CA 2, L.P., a Delaware limited partnership c/o Essential Housing Asset Management LLC 8585 E. Hartford Drive, Suite 118 Scottsdale, AZ 85255
Type and Size of Development Project (include no. of dwelling units or edus)	The Retreats North 52 Single Family Dwellings and 473,371 of open space and landscaping.
Development Project Real Property	_____ Co. APN(s): See attached map, Exhibit A
Date of Developer Agreement	June 12, 2015

WHEREAS, the District and the property owner named above (“Developer”) have approved the Developer Agreement Concerning Construction and Transfer of Utility System Improvements dated as indicated above and for the development project described above (the “Agreement”);

WHEREAS, Developer through a contractor has completed the construction and installation of the utility system improvements (described as the “Work” in the Agreement) in accordance with the terms and conditions of the Agreement;

WHEREAS, the District engineer has finally inspected, tested and approved the completed Work on behalf of the District, and the engineer has recommended acceptance of the Work by the District;

WHEREAS, the Developer has transferred all of its right, title and interest in the Work to the District by way of a Bill of Sale dated July 12, 2023 (“Bill of Sale”);

WHEREAS, the District finds that all preconditions of the Agreement to the transfer of the Work have been satisfied, and that the District is now ready and able to accept the completed Work and Bill of Sale pursuant to the Agreement;

NOW, THEREFORE, BE IT RESOLVED by the Board of Directors of the Rancho Murieta Community Services District as follows:

1. The District accepts the Bill of Sale from the Developer.
2. The District accepts the completed Work pursuant to the terms of the Agreement.

3. After the date of this resolution, the District (a) will own, operate and maintain the District-Owned Improvements portion of the Work as described in the Agreement and as shown on the District-approved utility system improvement plans for the Work, and (b) provide water, sewer, and drainage service to the development project described above, on and subject to the terms of the Agreement, applicable District ordinances, resolutions, regulations, rules, policies, and rates and charges (as the same may be amended from time to time), and other applicable laws and regulations.

PASSED AND ADOPTED this 19 day of July, 2023 by the following roll call vote:

AYES:

NOES:

ABSTAIN:

ABSENT:

Timothy E. Maybee, Board President

Attest:

Amelia Wilder, District Secretary

RANCHO MURIETA COMMUNITY SERVICES DISTRICT
DIRECTOR OF FINANCE AND ADMINISTRATION

DEPARTMENT: ADMINISTRATION

FLSA OVERTIME STATUS: EXEMPT

BARGAINING UNIT: N/A

APPROVED BY BOARD OF DIRECTORS – TBD

SUMMARY: Under general direction, the Director of Finance and Administration (DFA) is responsible for the overall administrative effectiveness of the Rancho Murieta Community Services District (the District). The position reports to and assists the General Manager. The position coordinates and directs all of the District's financial functions including financial analysis and management, planning, reporting, compliance, policy and procedure development, capital investment analysis, risk management and business planning. The DFA oversees all aspects of the human resources and information technology programs. This position will act as primary financial contact within the organization.

SUPERVISION: Directly supervises accounting, administrative and office staff.

ESSENTIAL DUTIES AND RESPONSIBILITIES include the following. These are not to be construed as exclusive or all-inclusive. Other related duties may be required and assigned.

- Serve as the lead on all resource activities, policies, and procedures, including recruitment and on/off boarding, records management, Injury/Illness Prevention Program management, training,
 - May assist the General Manager and/or Board of Directors in contract negotiations, grievance review and response, and employee discipline .
- Serve as the subject matter expert for financial system; Manage resources and administer all systems;
- Administer and Track procurement and private vendor contracting;
- Develop and manage the annual operating and capital budgets and business plan;
- Prepare and submit to the General Manager all financial reporting, including
 - i. Monthly Bank Reconciliations;
 - ii. Quarterly Budget to Actual Reports;
 - iii. Annual Sources and Uses Report;
 - iv. Annual Fund Condition Statements;
 - v. Annual Balance Sheets.
- Ensure accurate and timely financial reporting to General Manager and the Board of Directors, and other managers on a monthly, quarterly and annual basis;

- Oversee Billing and Accounts Receivable functions;
- Oversee Accounts Payable;
- Oversee Payroll processing and Reporting;
- Oversee Banking Transactions, cost allocations, and reconciliations;
- Oversee Retirement Plans, Benefit Programs, Insurance Policies and Claims;
- Oversee and manage treasury and debt functions and reporting;
- Manage, coordinate, and coach five direct reports;
- Participate in the development of the District's annual and Five-year capital plans;
- Oversee District risk management function including general risk management and procurement. Work with the District's Risk Management Authority to optimize the District's risk position;
- Lead financial analysis that may include identification and consideration of new District opportunities, operational benchmarking, cost saving/efficiency initiatives;
- Contribute to the business's financial strategies and plans that align with Strategic Objectives and Financial Strategies;
- Perform Return of Investment (ROI) analysis on District investments;
- Assist in prioritizing capital maintenance requirements;
- Manage the development of a business forecasting culture which will enable the business to respond to changes and business trends;
- Prepare month-end journal entries and assist with the month-end close;
- Prepare balance sheet account reconciliations;
- Prepare and review the operating financial statements for the District;
- Review, approve, and monitor monthly financial results including Sources and Uses, Balance Sheet, and Reserve Reporting;
- Review, approve and monitor working capital reporting;
- Review annual and monthly budgets and working capital forecasts;
- Assist with year-end audit process;
- Develop any reports needed to track key performance indicators to aid General Manager in proactively monitoring District performance;
- Develop, improve and implement policies, procedures, and internal accounting controls;
- Respond to customer service concerns requiring upper management intervention;

- Direct process improvement initiatives including but not limited to cross-training of staff and transition planning;
- Oversee the District Information Technology (IT) Function including procurement, implementation and operation of the District's technology functions. Work closely with the District's contracted IT support vendor to implement and manage District technology.

GENERAL QUALIFICATIONS

Rancho Murieta Community Services District employees must possess essential general qualifications including integrity, initiative, dependability, good judgment, and ability to work cooperatively with others. Strong ethical foundation with high integrity; self-motivated and results driven; assertive and decisive; ability to train, mentor, and develop employees; ability to work with and relate to employees at all levels of the organization; dynamic, pro-active, resourceful and practical; strong organizational skills with a proven ability to handle multiple tasks in a time sensitive manner; excellent written and verbal communication skills.

Applicants must demonstrate the ability to perform high administrative and policy – influencing functions effectively. Such overall ability requires possession of most of the following more specific knowledge and abilities:

1. Knowledge of the organization and functions of California State and Local Government; principles, practices, and trends of public administration, organization, and management; techniques of organizing and motivating groups; program development and evaluation; methods of administrative problem solving; principles and practices of policy formulation and development; and personnel management techniques; the organization's Equal Employment Opportunity Program objectives; and a manager's role in the Equal Employment Opportunity Program.
2. Ability to plan, organize, and direct the work of multidisciplinary professional and administrative staff; analyze administrative policies, organization, procedures and practices; integrate the activities of a diverse program to attain common goals; gain the confidence and support of senior managers and Board members and advise them on a wide range of administrative matters; develop cooperative working relationships with representatives of all community organizations, the public, and State and County officials; analyze complex problems and recommend effective courses of action; and prepare and review reports; and effectively contribute to the organization's Equal Employment Opportunity objectives.

MINIMUM QUALIFICATIONS

Strong computer software skills, including the Microsoft Office suite, especially Excel, FileMaker or other database experience. Experience in Accounting/Payroll and utility billing systems such as PayChex, Great Plains, Tyler, and Utility Star;

Intermediate understanding of technology systems and hardware solutions key to a modern office environment. Principles and practices of pertinent Federal, State, and local laws, rules, and regulations governing accountability of public agency funds.

Education: BA/BS degree in accounting, finance, business administration, human resources, public administration or closely related field. Masters degree desirable.

Experience: Five (5) years of increasingly responsible experience performing effective governmental administration including supervision, budget preparation, personnel management, public program analysis, analytical report preparation, and computer system (hardware, software, network and peripherals) application maintenance.

LICENSE AND/OR CERTIFICATES: Possession of a current California Driver's license required by the State Department of Motor Vehicles to perform the essential duties of the position. Continued maintenance of a valid driver's license, insurability, and compliance with established District vehicle operation standards are a condition of continuing employment.

PHYSICAL DEMANDS: Ability to operate a variety of automated office machines; significant typing and writing activity; exert light physical effort in sedentary to light work involving sitting most of the time, but may involve walking or moving from one area to another or standing for brief periods of time. Ability to exert negligible amount of force frequently or constantly to lift, carry, push, pull or otherwise move objects. The employee must occasionally lift and/or move up to 5 pounds.

WORK ENVIRONMENT: The work environment characteristics described here are representative of those an employee encounters while performing the essential functions of this job. Reasonable accommodations may be made to enable individuals with disabilities to perform the essential functions. The noise level in the work environment is usually quiet.

DESIRABLE QUALIFICATIONS

*Demonstrated knowledge of fiscal programs, policies and procedures, including business services, procurement, contracting, grants management, accounting, and budgeting.

*Demonstrated experience in directing a complete program of decentralized administrative services with emphasis on management of complex fiscal systems, business services, and administrative services while ensuring efficient customer services and completion of tasks within established timeframes and maintaining a cohesive team.

*Demonstrated leadership and experience in program management and team building including differing opinions, viewpoints, perspectives, needs and interests.

*Demonstrated knowledge of the District's programs and the ability to communicate and advance the District's mission to control agencies, the Legislature, other local, state, and federal agencies as well as stakeholders.

*Demonstrated experience in making recommendations on legislation and legislative proposals which affect the District's business services functions as well as other financial programs, including grants, accounting and budgeting.

*Demonstrated broad experience that includes substantial participation in the formulation, operation, and/or evaluation of program policies along with the ability to analyze complex program implementation problems and develop effective courses of action to solve them.

MEMORANDUM

Date: July 19, 2023
To: Board of Directors
From: Michael Fritschi, P.E. – Operations Director
Subject: Lift Station 3B Construction Contract – CIP #23-11-02

Proposed Action

Staff recommend the Board consider the bid for construction contract of \$141,334 by TNT Industrial Contractors, INC to perform rehabilitation of Lift Station 3B.

Background

Lift Station 3B serves a handful of homes along Camino Del Lago and Clementia Circle and serves the District Water Treatment Facility. Most critically, the flow from the water treatment plant to the lift station, in part, consists of the (3) daily membrane cleaning chemical washes. This disposal of the wash water makes this lift station a very important component to the daily processing of potable water from plant 1.

Over the years, the pumps in Lift Station 3B have become worn and obsolete. The original control panel was composed of a single-phase system that is much less operationally redundant than the more modern 3-phase systems. The single-phase pumps are also difficult to repair and find replacement parts and pumps for. The piping, check valves, and isolation valves have also become worn and corroded and need replacement. Currently the District is operating this station with (2) single-phase pumps that have modified impellers.

The District hired Domenicelli & Associates (Engineer) to put together the design for the rehabilitation of Lift Station 3B. The District will be utilizing owner furnished 3-phase replacement pumps, a new 3-phase control panel, and owner provided electrical labor. The Contractor is responsible for bypassing sewage for 350 feet to the nearest downstream manhole, demolishing and replacing all process piping and valves, and installing the District furnished pumps and equipment.

The District put the project out to bid on June 12th and listed the project in the Sacramento Builder's Exchange, the California Special Districts Association, and the District Website. The due date for the bids was July 13th at 4:00 PM. On July 13th, the District received a single bid from TNT Industrial Contractors, INC in the amount of \$141,334 to perform the work.

The Engineer had an informal estimate of \$110,000 - \$120,000 for the contract work to be completed. The Engineer mentioned that their firm has experienced a recent trend of projects being bid somewhat higher than their estimates or cost opinions.

The District options are to accept the contract as bid, re-bid the project, or not perform the work. The cost of the owner furnished replacement pumps is \$24,877, the electrical panel and the

electrical work is \$48,000. The recent bid of \$141,334 will bring the project total to \$214,211, not including design costs. Of that total, about \$50,000 of the equipment has been pre-purchased under the previous fiscal year. When the work is complete, it will basically be a new lift station. The CIP budget for lift station renewal is at \$750,000 and is shared between Alameda & Starter Shack station rehabilitation projects and generator projects for Cantova and FAA lift stations.

RANCHO MURIETA COMMUNITY SERVICES DISTRICT

RANCHO MURIETA, CALIFORNIA

LIFT STATION 3B REHABILITATION

JUNE 2023

INDEX OF DRAWINGS

DWG	SHEET	TITLE
G1	1	COVER SHEET
G2	2	GENERAL NOTES, ABBREVIATIONS & SYMBOLS
C1	3	DEMOLITION PLAN AND SECTION
C2	4	RENOVATION PLAN AND SECTION
C3	5	DETAILS

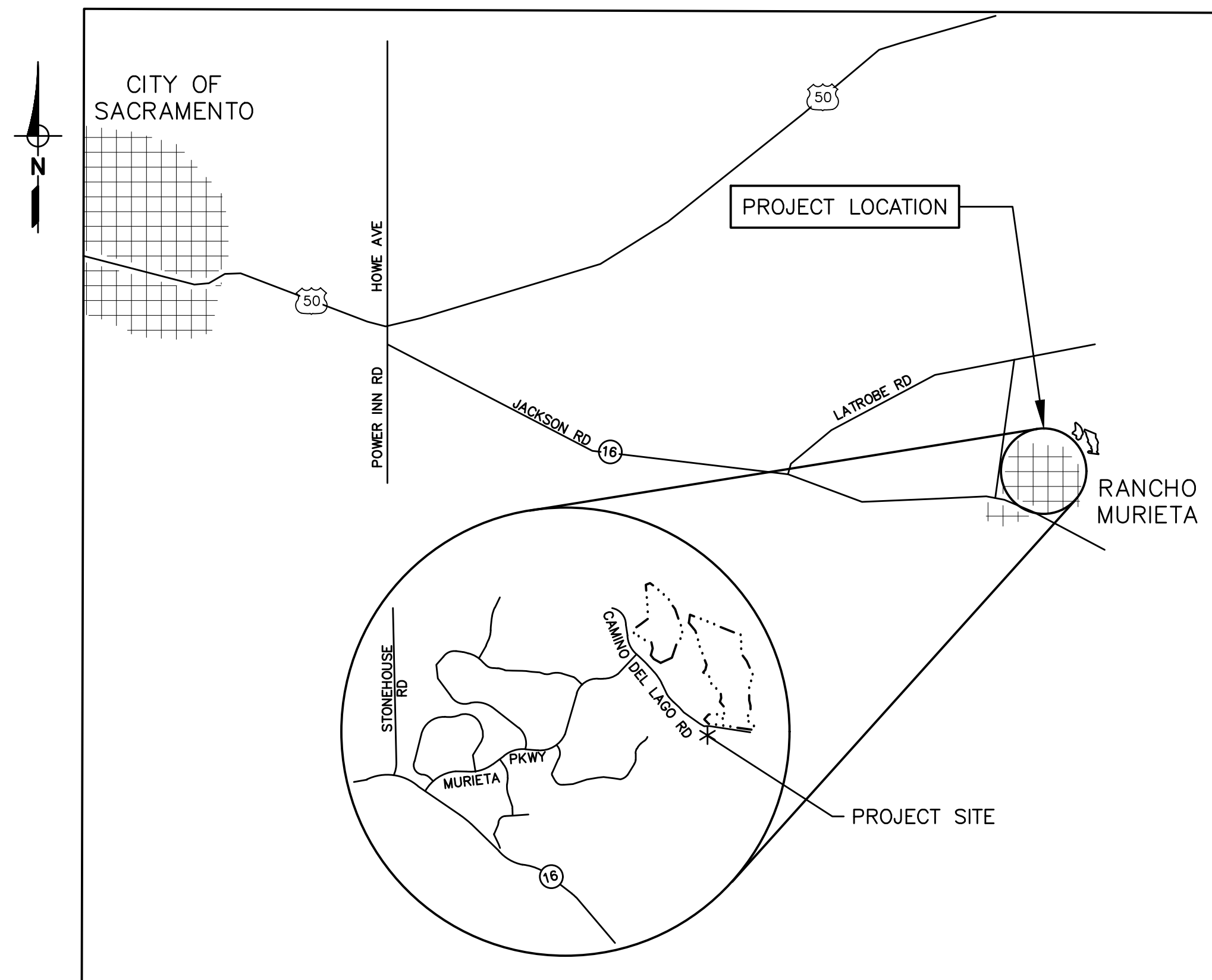

LOCATION MAP

NOT TO SCALE

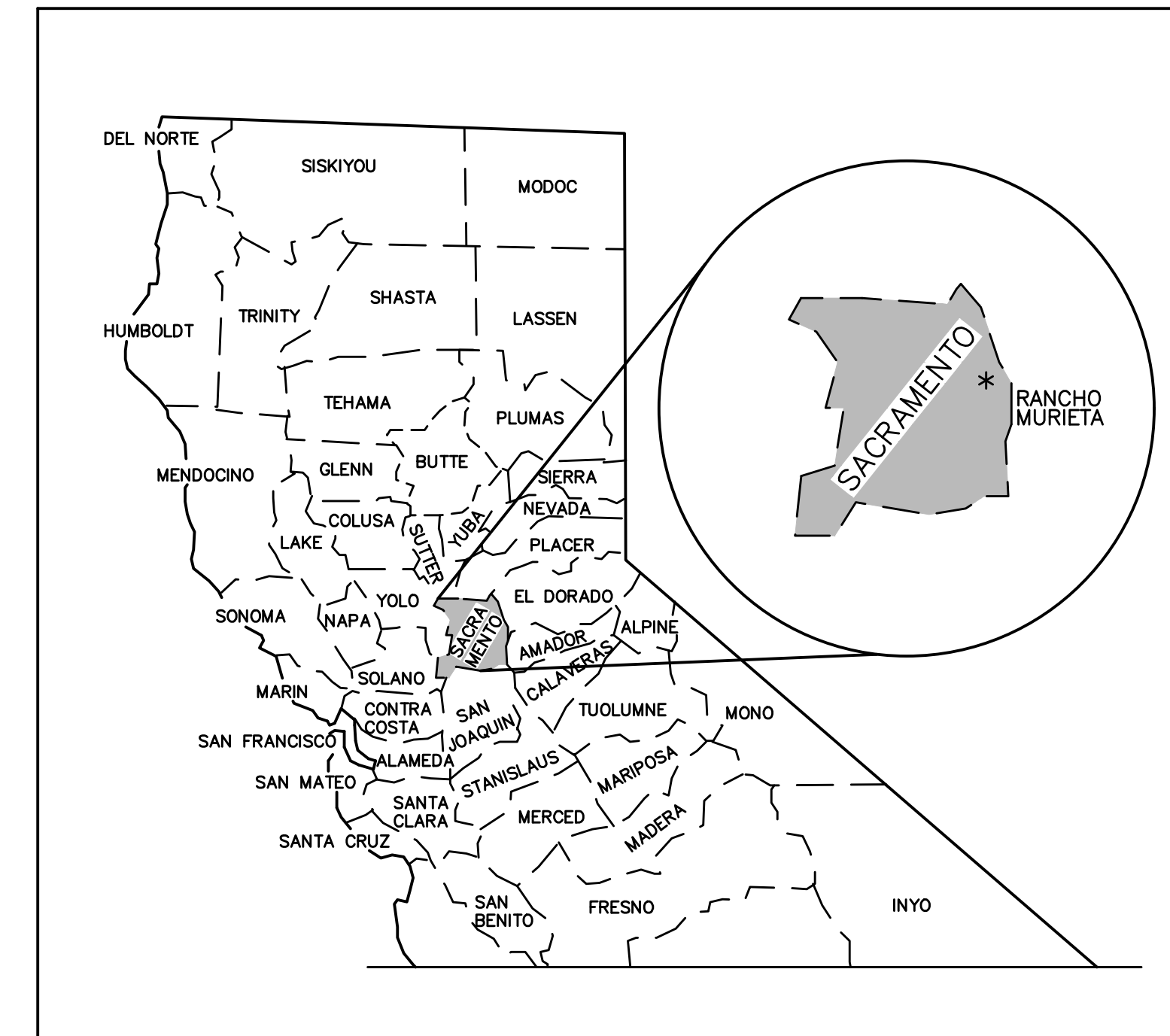

VICINITY MAP

NOT TO SCALE

APPROVED ON _____

RESOLUTION NO. _____

RANCHO MURIETA COMMUNITY SERVICES DISTRICT

DATE _____

DOMENICHELLI & ASSOCIATES

DATE _____

Z:\RM-ONCALL 3-21 TO 3-24\RM-031 LIFT STATION UPGRADES\DWGS\LIFT STATION 3B\X-RMCSD BDR.DWG

REVISIONS				
REV	DESCRIPTION	DATE	BY	CHKD

WARNING
 0 1"
 AT FULL SCALE
 (IF BAR IS NOT 1" - SCALE
 ACCORDINGLY)

DESIGNED: D. HEIGHER
 DRAWN: J. CADE
 CHECKED: J. DOMENICHELLI
 DATE: JUNE 2023

DOMENICHELLI & ASSOCIATES
 Domenichelli & Associates
 5180 Golden Foothill Pkwy, Suite 220 Ph: (916) 933-1997
 El Dorado Hills, CA 95762 Fax: (916) 933-4778

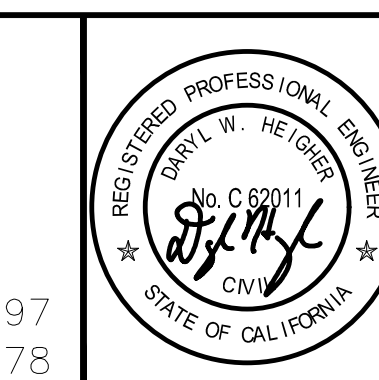

Rancho Murieta
 Community Services District

15160 Jackson Road, Rancho Murieta
 (916) 354 3700

RANCHO MURIETA COMMUNITY SERVICES
 LIFT STATION 3B REHABILITATION

COVER SHEET

DRAWING NUMBER	G1
FILENAME	
RLWD FILE NO.	

GENERAL NOTES

- WORK INCLUDED (BUT NOT LIMITED TO):
 - ALL WORK SHALL CONFORM TO THE APPLICABLE LOCAL, STATE AND FEDERAL CODES AND SPECIFICATIONS INCLUDING OSHA.
 - IT IS THE CONTRACTORS RESPONSIBILITY TO ASSURE JOB SAFETY. LOCAL, STATE AND FEDERAL, INCLUDING OSHA, LAWS AND RULES SHALL BE ENFORCED BY THE CONTRACTOR AT ALL TIMES.
 - THE CONTRACTOR SHALL NOTIFY UNDERGROUND SERVICE ALERT (USA), (800) 642-2444, 48 HOURS PRIOR TO ANY EXCAVATION. THE CONTRACTOR SHALL ALSO NOTIFY ALL OTHER UTILITIES, NOT IN USA, 48 HOURS PRIOR TO ANY EXCAVATION.
 - ALL STRUCTURES AND FACILITIES DAMAGED BY CONTRACTOR SHALL BE REPAIRED OR REPLACED AT CONTRACTOR'S EXPENSE.
- PUBLIC SAFETY AND TRAFFIC CONTROL PLAN SHALL BE PROVIDED IN ACCORDANCE WITH THE GENERAL SPECIFICATIONS. SAFE VEHICULAR AND OPERATION STAFF ACCESS SHALL BE PROVIDED AT ALL TIMES DURING CONSTRUCTION.
- EROSION CONTROL MEASURES SHALL BE IN ACCORDANCE WITH THE SPECIFICATIONS AND SACRAMENTO COUNTY BMPS.
- THE TYPES, LOCATIONS, SIZES, AND/OR DEPTHS OF EXISTING UNDERGROUND UTILITIES AS SHOWN ON THESE IMPROVEMENT PLANS WERE OBTAINED FROM SOURCES OF VARYING RELIABILITY. THE CONTRACTOR IS CAUTIONED THAT ONLY ACTUAL EXCAVATION WILL REVEAL THE TYPES, EXTENT, SIZES, LOCATIONS, AND DEPTHS OF SUCH UNDERGROUND UTILITIES. A REASONABLE EFFORT HAS BEEN MADE TO LOCATE AND DELINEATE ALL KNOWN UNDERGROUND UTILITIES. HOWEVER, THE DISTRICT CAN ASSUME NO RESPONSIBILITY FOR THE COMPLETENESS OR ACCURACY OF THE DELINEATION OF SUCH UNDERGROUND UTILITIES NOR FOR THE EXISTENCE OF OTHER BURIED OBJECTS OR UTILITIES WHICH MAY BE ENCOUNTERED BUT WHICH ARE NOT SHOWN ON THESE DRAWINGS. IT IS THE CONTRACTOR'S RESPONSIBILITY TO VERIFY ACTUAL LOCATIONS.
- ALL CONSTRUCTION SHALL CONFORM TO THESE PLANS AND SPECIFICATIONS.
- THE CONTRACTOR SHALL NOTIFY THE DISTRICT CONSTRUCTION INSPECTION SUPERVISOR AT (916) 354-3700 48 HOURS PRIOR TO INTENDED START OF WORK TO ARRANGE A PRE-CONSTRUCTION FIELD MEETING AND SHALL VERIFY AT THIS TIME THAT THE INSPECTOR HAS RECEIVED COPIES OF THE APPROVED PLANS. NO CONSTRUCTION MAY BE DONE PRIOR TO THIS MEETING.
- COMPLIANCE WITH NOISE RESTRICTIONS IS REQUIRED. HOURS OF CONSTRUCTION OPERATION SHALL BE LIMITED FROM 7:00 A.M. TO 6:00 P.M. WEEKDAYS. NO SATURDAY WORK SHALL BE ALLOWED UNLESS APPROVED BY THE DISTRICT. NO SUNDAY WORK IS APPROVED. CONSTRUCTION EQUIPMENT SHALL BE MUFFLED AND SHROUDED TO MINIMIZE NOISE LEVELS IN ACCORDANCE WITH MANUFACTURER'S RECOMMENDATIONS.
- NO REFUELING, LUBRICATION, OR MAINTENANCE OF CONSTRUCTION VEHICLES SHALL BE DONE ANYWHERE ON THE SITE EXCEPT WITHIN APPROVED CONSTRUCTION STAGING AREAS.
- PRIOR TO COMMENCEMENT OF ANY WORK SHOWN ON THESE PLANS LOCATED WITHIN EXISTING PUBLIC RIGHT-OF-WAY, THE CONTRACTOR SHALL OBTAIN AN ENCROACHMENT PERMIT FROM SACRAMENTO COUNTY PLANNING, INSPECTION, AND PERMITTING DEPARTMENT. THE CONTRACTOR WILL BE REQUIRED TO POST A PERFORMANCE BOND AND PROVIDE PROOF OF INSURANCE NAMING THE DISTRICT AS ADDITIONALLY INSURED.
- CONTRACTOR SHALL BE RESPONSIBLE FOR DRAINING AND CLEANING OF THE EXISTING WET WELL.
- CONTRACTOR SHALL BE RESPONSIBLE FOR BYPASSING SEWAGE FLOW AROUND THE WORK SITE. 100 GALLONS PER MINUTE AT 35 FT. OF HEAD.

ARCHAEOLOGY NOTE

SHOULD ANY CULTURAL RESOURCES, SUCH AS STRUCTURAL FEATURES, UNUSUAL AMOUNTS OF BONE OR SHELL, ARTIFACTS, HUMAN REMAINS, OR ARCHITECTURAL REMAINS BE ENCOUNTERED DURING ANY DEVELOPMENT ACTIVITIES, WORK SHALL BE SUSPENDED AND THE OWNER SHALL BE NOTIFIED IMMEDIATELY. CONTRACTOR SHALL COMPLY WITH ALL CONTRACT REQUIREMENTS FOR PROTECTION OF CULTURAL AND ARCHITECTURAL RESOURCES.

CONSTRUCTION WATER

ALL CONSTRUCTION WATER TO BE OBTAINED FROM AN APPROVED LOCATION BY RANCHO MURIETA COMMUNITY SERVICES DISTRICT.

LEGEND & SYMBOLS

	FLANGED JOINT		POWER/TELEPHONE
	MECHANICAL JOINT		WATER SERVICE REGULATOR OR WATER METER
	WELDED JOINT		FIRE HYDRANT
	BELL & SPIGOT JOINT (LEADED)		LIGHT POLE
	BALL JOINT		SIGN
	GROOVED END JOINT		PROPERTY LINE
	FLANGED COUPLING ADAPTER		EXISTING SEWER
	FLEXIBLE COUPLING		NEW SEWER
	FLEXIBLE COUPLING WITH THRUST TIES		EXISTING NON-POTABLE WATER LINE
	STEEL BELLOWS EXP JOINT		NEW NON-POTABLE WATER LINE
	ELASTOMER BELLOWS EXP JOINT		WATER LINE
	ELBOW UP		MANHOLE
	ELBOW DOWN		THRUST BLOCK
	TEE UP		CATCH BASIN
	TEE DOWN		FENCE
	LATERAL UP		GAS LINE
	LATERAL DOWN		TELEPHONE CONDUIT
	ELBOW 90°		ELECTRICAL CONDUIT
	CROSS		CONTOUR ELEVATION
	TEE		POINT ELEVATION
	ELBOW 45°		SLOPE
	LATERAL		TREES OR SHRUBBERY
	CONCENTRIC REDUCER		LANDSCAPED AREA
	ECCENTRIC REDUCER		TEST BORING LOCATION AND NO.
	UNION		EXISTING BUILDING
	CAP (WELDED)		NEW BUILDING
	TRAP		CONCRETE PAVEMENT
	VENT		ASPHALT PAVEMENT
	WYE		DRAINAGE COURSE OR FLOW LINE
	BURIED VALVE W/ BOX		EXISTING GROUND CONTOUR
	BALL VALVE		FINISH GRADE CONTOUR
	BUTTERFLY VALVE		STRUCTURAL CONTINUATION
	CHECK VALVE		CONCRETE
	DIAPHRAGM VALVE		GROUT
	GATE VALVE		ROAD BASE
	PUMP CONTROL VALVE		DRAIN GRAVEL OR GRANULAR MATERIAL
	PRESSURE RELIEF VALVE		COARSE BASE ROCK
	PLUG VALVE		FINISHED WOOD
	3 WAY VALVE		ROUGH WOOD, CONTINUOUS
	4 WAY VALVE		INSULATION
	VACUUM RELIEF VALVE		MASONRY BLOCK
	BACKFLOW PREVENTER		EARTH OR GRADE
	BLIND FLANGE		EARTH FILL
	DOUBLE MECHANICAL JOINT		CHECKERED PLATE
	PVC JOINT		GRATING
	EXPANSION COUPLING		STEEL
	PIPE CONTINUATION		PIPE SUPPORTS
	PIPE CONTINUATION, END VIEW		CONDUIT
	CLEAN OUT		PUMP, CENTRIFUGAL
	DRAIN OR BELL-UP		PUMP, VARIABLE SPEED
	FILTER		PUMP, PROGRESSIVE CAVITY
	FLEXIBLE HOSE OR TUBING		SLEEVE
	FLOWMETER		STRAINER
	FLOWTUBE		WATER SERVICE
	FREE SURFACE		
	GAGE, PRESSURE (W/COCK)		
	HOSE BIBB 3/4" W/HOSE THREAD		
	YARD HYDRANT, FREEZE PROOF		
	HOSE CONNECTION		
	HOSE RACK		
	ORIFICE PLATE		
	PUMP, CENTRIFUGAL		
	PUMP, VARIABLE SPEED		
	PUMP, PROGRESSIVE CAVITY		
	SLEEVE		
	STRAINER		
	WATER SERVICE		

ABBREVIATIONS

@	AT	L	ANGLE
A.C.	ASPHALT CONCRETE	LB	POUNDS
A.B.	AGGREGATE BASE	LF.	LINEAR FEET
ARV	AIR RELEASE VALVE	LT.	LEFT
		LR	LONG RADIUS
BF	BLIND FLANGE	MAX.	MAXIMUM
BFV	BUTTERFLY VALVE	MECH	MECHANICAL
BLDG	BUILDING	MFR.	MANUFACTURER
B.M.	BENCH MARK	MH	MANHOLE
BOF	BOTTOM OF FLANGE	MIN.	MINIMUM
BOF*	BOTTOM OF FLANGE, NOT INCLUDING BOLTS	MISC.	MISCELLANEOUS
BOP	BOTTOM OF PIPE	MJ	MECHANICAL JOINT
BOS	BOTTOM OF STAIRS	MO	MASONRY OPENING
BW	BACKWASH WATER		
CIP	CAST IN PLACE	(N)	NEW
CLG	CEILING	NO, OR #	NUMBER
CLR	CLEAR	NTS	NOT TO SCALE
CL	CENTERLINE	O.C.	ON CENTER
CMP	CORRUGATED METAL PIPE	OF	OVERFLOW
CO	CLEANOUT	OZ	OUNCE
CONC.	CONCRETE	P.E.	PLAIN END
CONT.	CONTINUOUS	PL.	PLATE (STEEL)
CPLG	COUPLING	PLYWD	PLYWOOD
C TO C	CENTER TO CENTER	PRESS.	PRESSURE
CV	CHECK VALVE	PL	PROPERTY LINE
		P.S.I.	POUND PER SQUARE INCH
d	PENNY (NAIL SIZE)	PW	POTABLE WATER
DET	DETAIL		
DIA	DIAMETER	R, OR RAD.	RADIUS
DIP	DUCTILE IRON PIPE	RD.	REDUCER
DWG	DRAWING	RDCR	REDUCER
		RDW	REDWOOD
(E)	EXISTING	RED	REDUCER
EA	EACH	RM	ROOM
ECC	ECCENTRIC	RO	ROUGH OPENING
EG	EXISTING GRADE	RTN	RETURN
EL	ELEVATION	RV	ROOF FENT
ELB	ELBOW	R/W	RIGHT-OF-WAY
ELEC	ELECTRIC, ELECTRICAL		
ESEW	EMERGENCY SHOWER & EYEWASH	SCHED.	SCHEDULE
EW	EACH WAY	SEC.	SECTION
EXH	EXHAUST	SH	SHEET
EX OR EXST.	EXISTING	SHT'G	SHEATHING
		SPEC.	SPECIFICATIONS
FC	FLEXIBLE COUPLING	SQ	SQUARE
FCA	FLANGED COUPLING ADAPTER	SST	STAINLESS STEEL
FCTRY	FACTORY	STA.	STATION
FD	FLOOR DRAIN	STD	STANDARD
FDN	FOUNDATION	STL	STEEL
FF	FINISH FLOOR	STRL	STRUCTURAL
FG	FINISH GRADE	STRUCT	STRUCTURE
FIG.	FIGURE		
FL	FLOOR	TAN	TANGENT
FLG	FLANGE	TARV	TOP OF AIR RELEASE VALVE
FL	FLOW LINE	TBG	TUBING
FM	FORCE MAIN	TECH	TECHNICAL
FT.	FOOT OR FEET	TEMP	TEMPERATURE
FTG.	FOOTING	THD	THREAD
		TOC	TOP OF CURB
GA.	GAGE	TOG	TOP OF GRATE
GAL.	GALLON	TOP	TOP OF PIPE
GALV.	GALVANIZED	TOR	TOP OF ROCK
GV	GATE VALVE	TOW	TOP OF WALL
		TYP.	TYPICAL
HDW	HARDWARE	TW	TREATED WATER
HORIZ	HORIZONTAL		
HP	HORSEPOWER	UBC	UNIFORM BUILDING CODE
HR	HOSE RACK	UNO	UNLESS NOTED OTHERWISE
		V	
IE	INVERT ELEVATION	VAC	VACUUM
IN.	INCH	VTR	VENT THRU ROOF
INSUL	INSULATION		
INV.	INVERT	WM	WATER METER
		WW	WASTE WATER
JT.	JOINT		
KIP	THOUSAND POUNDS		
KW	KILOWATT		

Z:\RM-ONCALL 3-21 TO 3-24\RM-031 LIFT STATION UPGRADES\DWG\LIFT STATION 3BX-RM-CSD BDR.DWG

REVISIONS				
REV	DESCRIPTION	DATE	BY	CHKD

WARNING

0 1"

AT FULL SCALE

(IF BAR IS NOT 1" - SCALE ACCORDINGLY)

DESIGNED: D. HEIGHER

DRAWN: J. CADE

CHECKED: J. DOMENICHELLI

DATE: JUNE 2023

DOMENICHELLI & ASSOCIATES

Domenicelli & Associates
5180 Golden Foothill Pkwy, Suite 220 Ph: (916) 933-1997
El Dorado Hills, CA 95762 Fax: (916) 933-4778

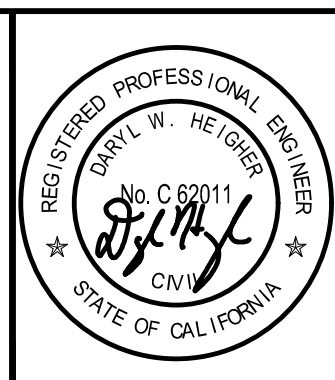

Rancho Murieta
Community Services District

15160 Jackson Road, Rancho Murieta
(916) 354 3700

RANCHO MURIETA COMMUNITY SERVICES
LIFT STATION 3B REHABILITATION

**GENERAL NOTES,
ABBREVIATIONS & SYMBOLS**

DRAWING NUMBER	G2
FILENAME	
RLWD FILE NO.	

Z:\RM-ONCALL 3-21 TO 3-24\RM-031 LIFT STATION UPGRADES\DWGS\LIFT STATION 3B\3B SITE.DWG

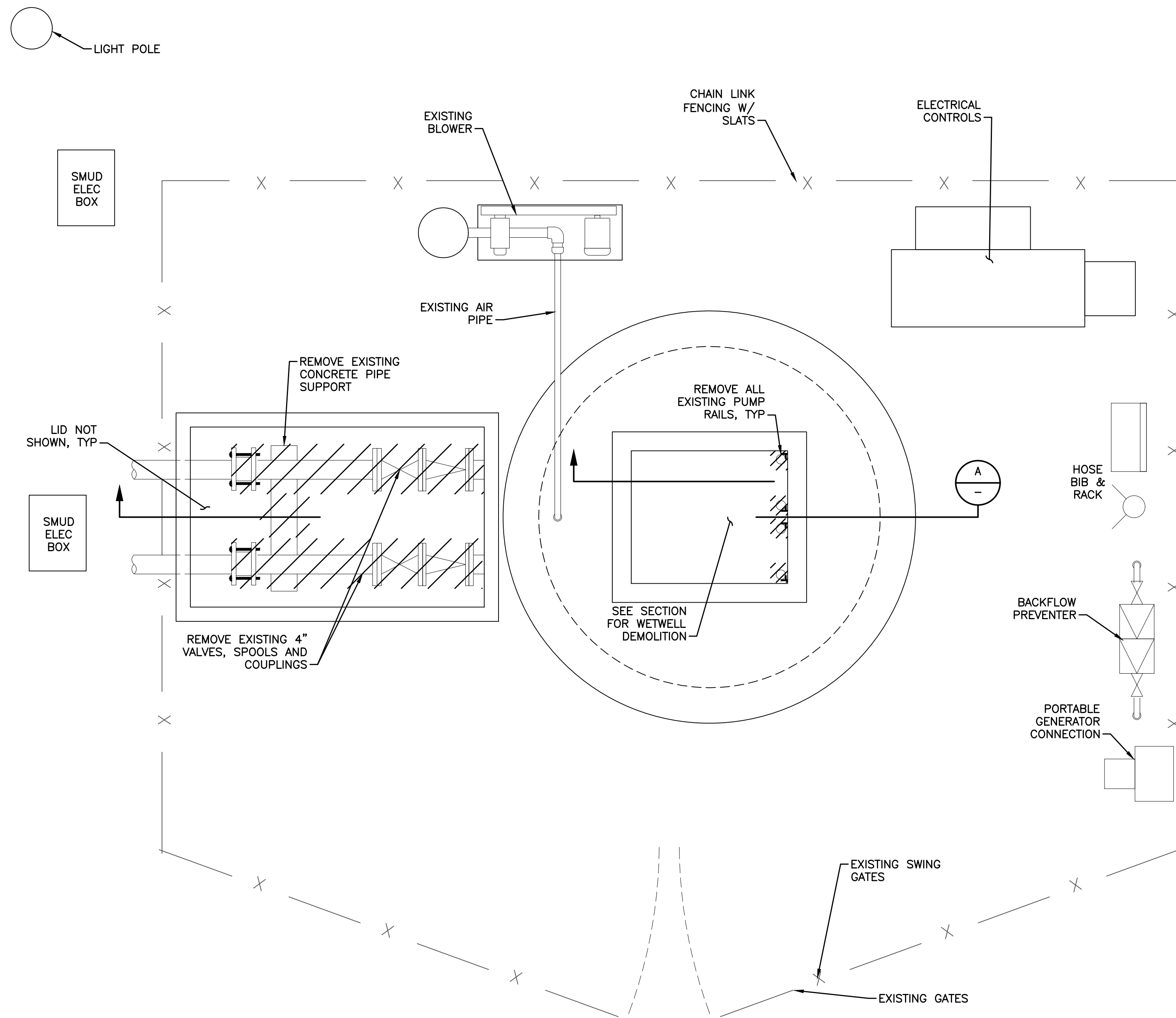

DEMOLITION PLAN
SCALE: 3/4" = 1'-0"

- NOTES:**
- CONTRACTOR SHALL DRAIN AND CLEAN EXISTING WET WELL.
 - CONTRACTOR SHALL PROVIDE A MEANS TO PUMP SEWAGE AROUND THE WORK SITE, 100 GALLON PER MINUTE AT 35ft OF HEAD. PROVIDE A PUMPING PLAN FOR DISTRICT APPROVAL PRIOR TO STARTING WORK.

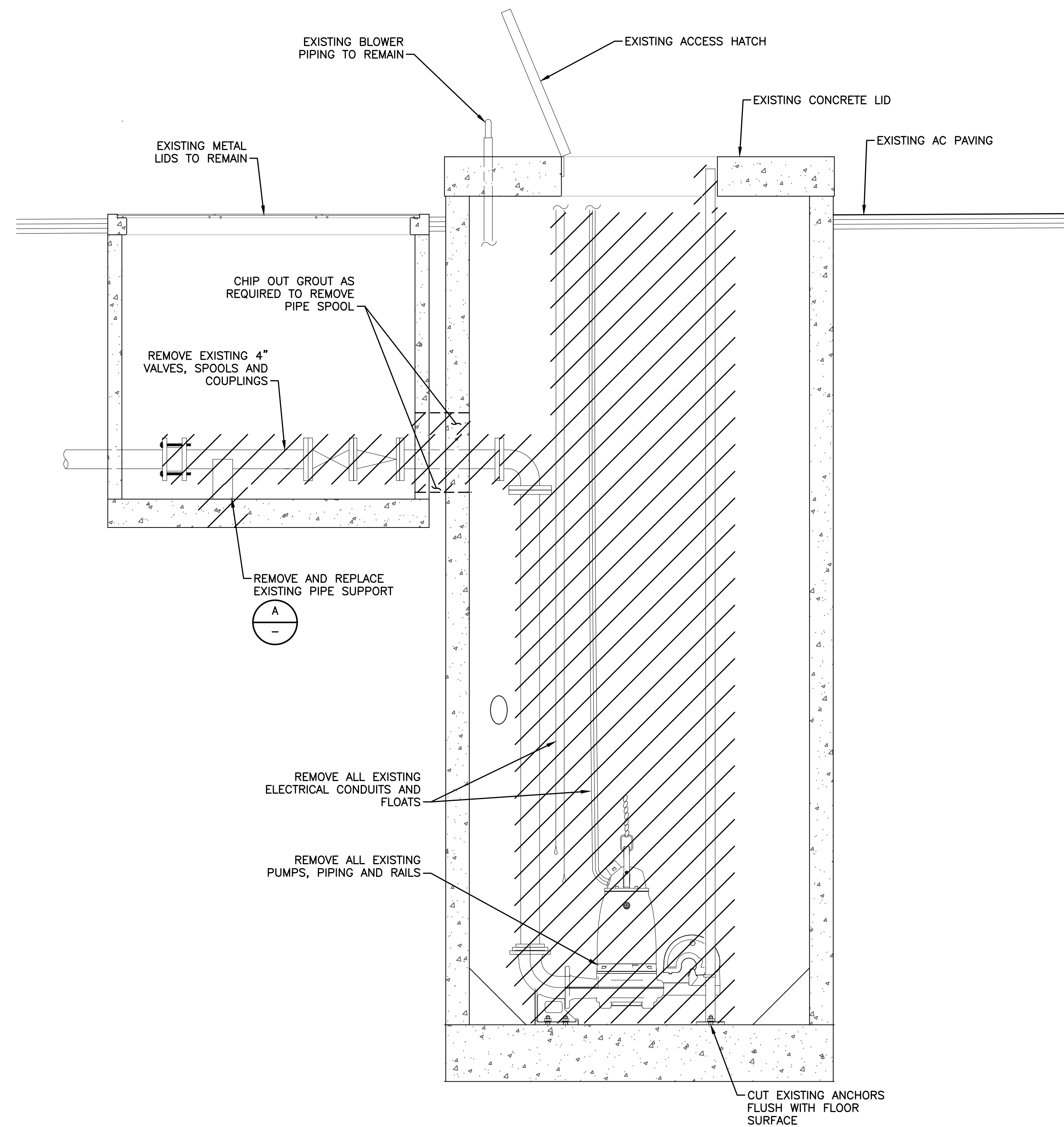

DEMOLITION SECTION A-A
SCALE: 3/4" = 1'-0"

REVISIONS				
REV	DESCRIPTION	DATE	BY	CHKD

WARNING

0 1"
AT FULL SCALE
(IF BAR IS NOT 1" - SCALE ACCORDINGLY)

DESIGNED: D. HEIGHER
DRAWN: J. CADE
CHECKED: J. DOMENICHELLI
DATE: JUNE 2023

DOMENICHELLI & ASSOCIATES

Domenicelli & Associates
5180 Golden Foothill Pkwy, Suite 220 Ph: (916) 933-1997
El Dorado Hills, CA 95762 Fax: (916) 933-4778

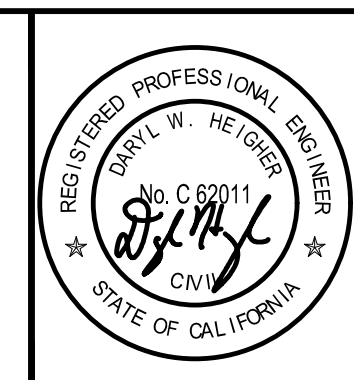

Rancho Murieta
Community Services District

15160 Jackson Road, Rancho Murieta
(916) 354 3700

RANCHO MURIETA COMMUNITY SERVICES
LIFT STATION 3B REHABILITATION

DEMOLITION PLAN & SECTION

DRAWING NUMBER	C1
FILENAME	
RLWD FILE NO.	

Z:\RM-ONCALL 3-21 TO 3-24\RM-031 LIFT STATION UPGRADES\DWGS\LIFT STATION 3B\3B SITE.DWG

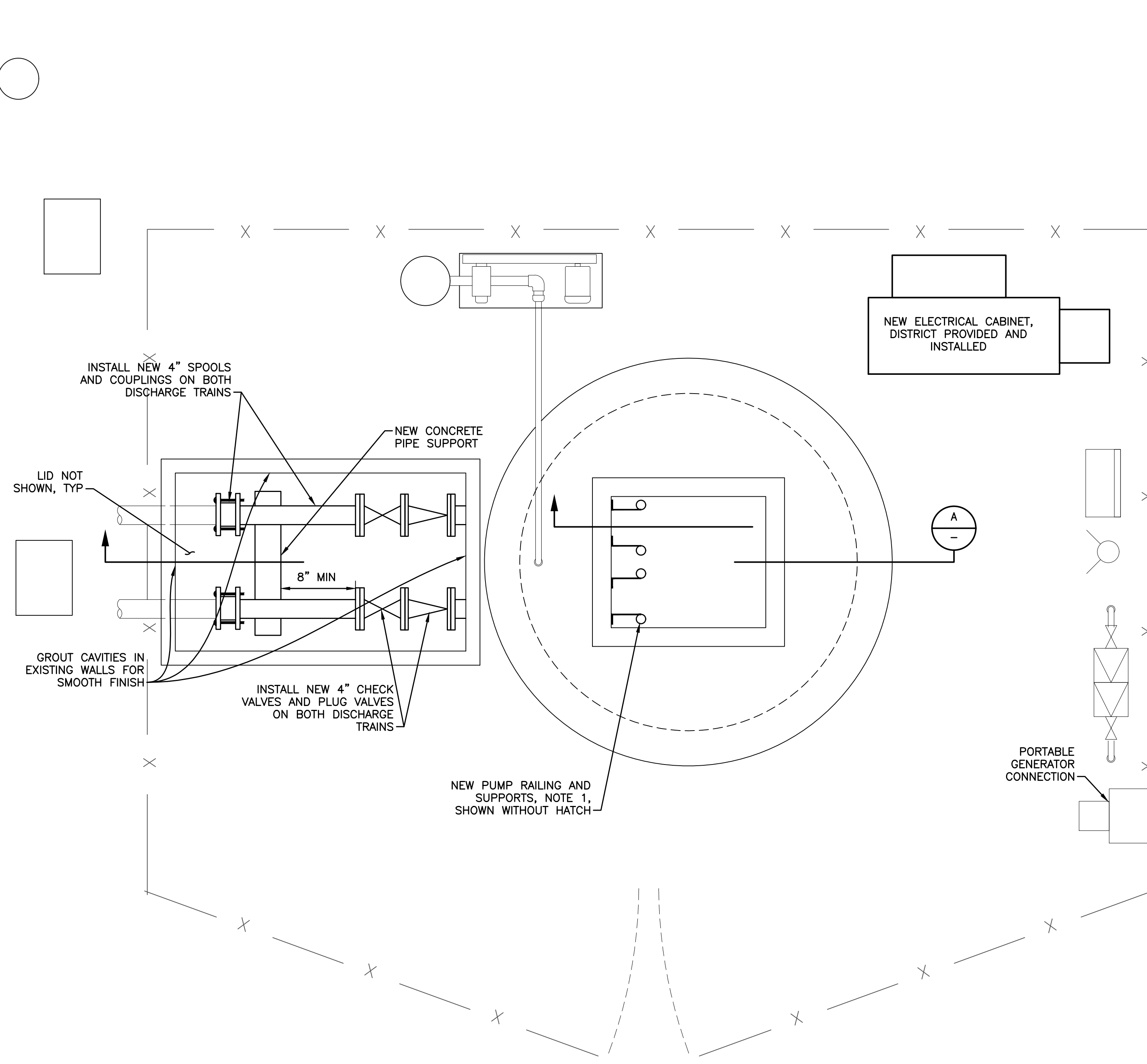

DEMO PLAN
SCALE: 3/4" = 1'-0"

- NOTES:**
- CONTRACTOR SHALL INSTALL NEW PUMP RAILS TO AVOID CONFLICTS BETWEEN THE PUMP MOUNTS, GUIDES AND EXISTING HATCH.

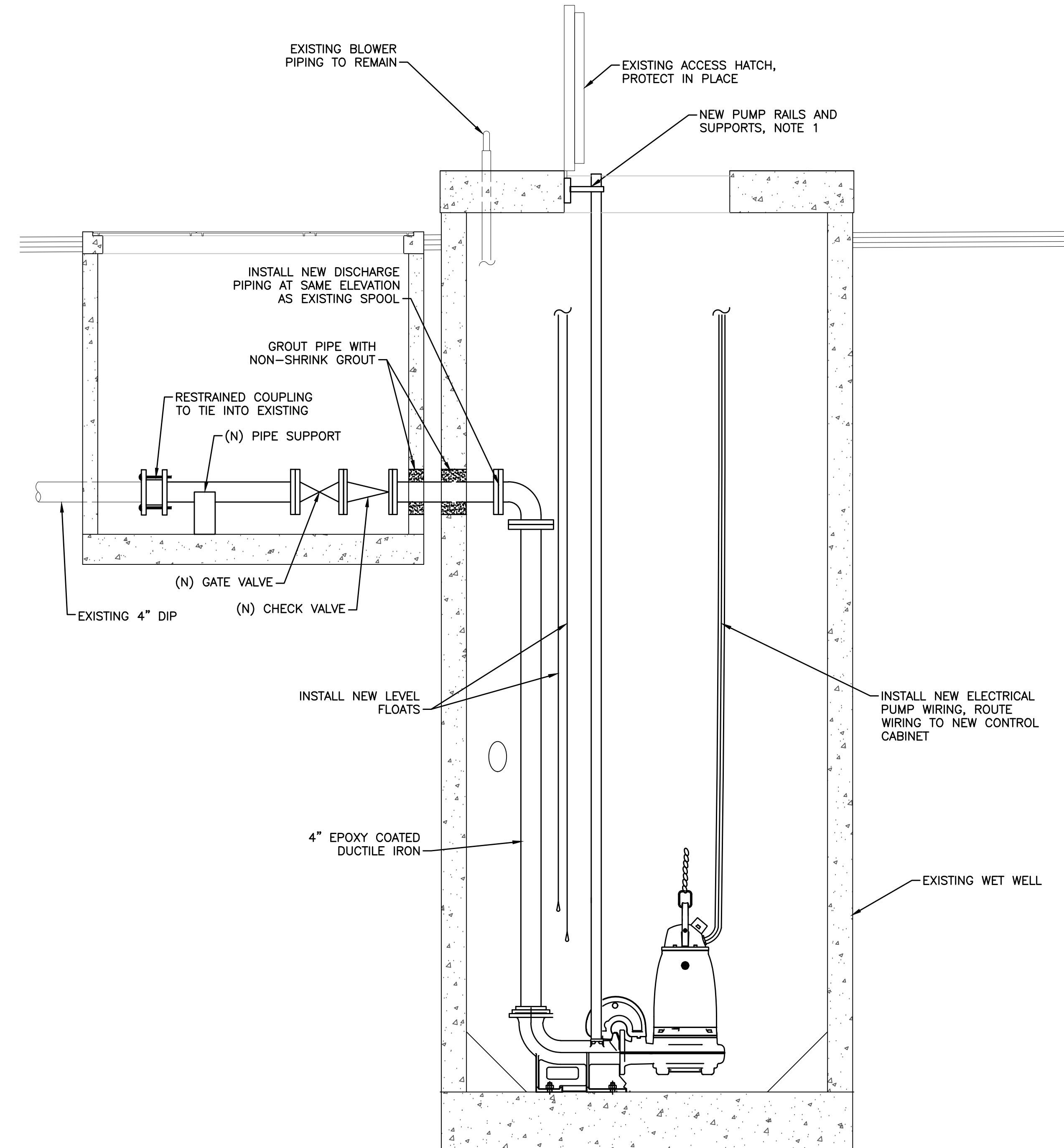

DEMO SECTION A
SCALE: 3/4" = 1'-0"

REVISIONS				
REV	DESCRIPTION	DATE	BY	CHKD

WARNING

0 1"
AT FULL SCALE
(IF BAR IS NOT 1" - SCALE ACCORDINGLY)

DESIGNED: D. HEIGHER
DRAWN: J. CADE
CHECKED: J. DOMENICHELLI
DATE: JUNE 2023

DOMENICHELLI & ASSOCIATES

Domenichelli & Associates
5180 Golden Foothill Pkwy, Suite 220 Ph: (916) 933-1997
El Dorado Hills, CA 95762 Fax: (916) 933-4778



Rancho Murieta
Community Services District

15160 Jackson Road, Rancho Murieta
(916) 354 3700

RANCHO MURIETA COMMUNITY SERVICES
LIFT STATION 3B REHABILITATION

RENOVATION PLAN & SECTION

DRAWING NUMBER	C2
FILENAME	
RLWD FILE NO.	

Z:\RM-ONCALL 3-21 TO 3-24\RM-031 LIFT STATION UPGRADES\DWGS\LIFT STATION 3B\3B DET.DWG

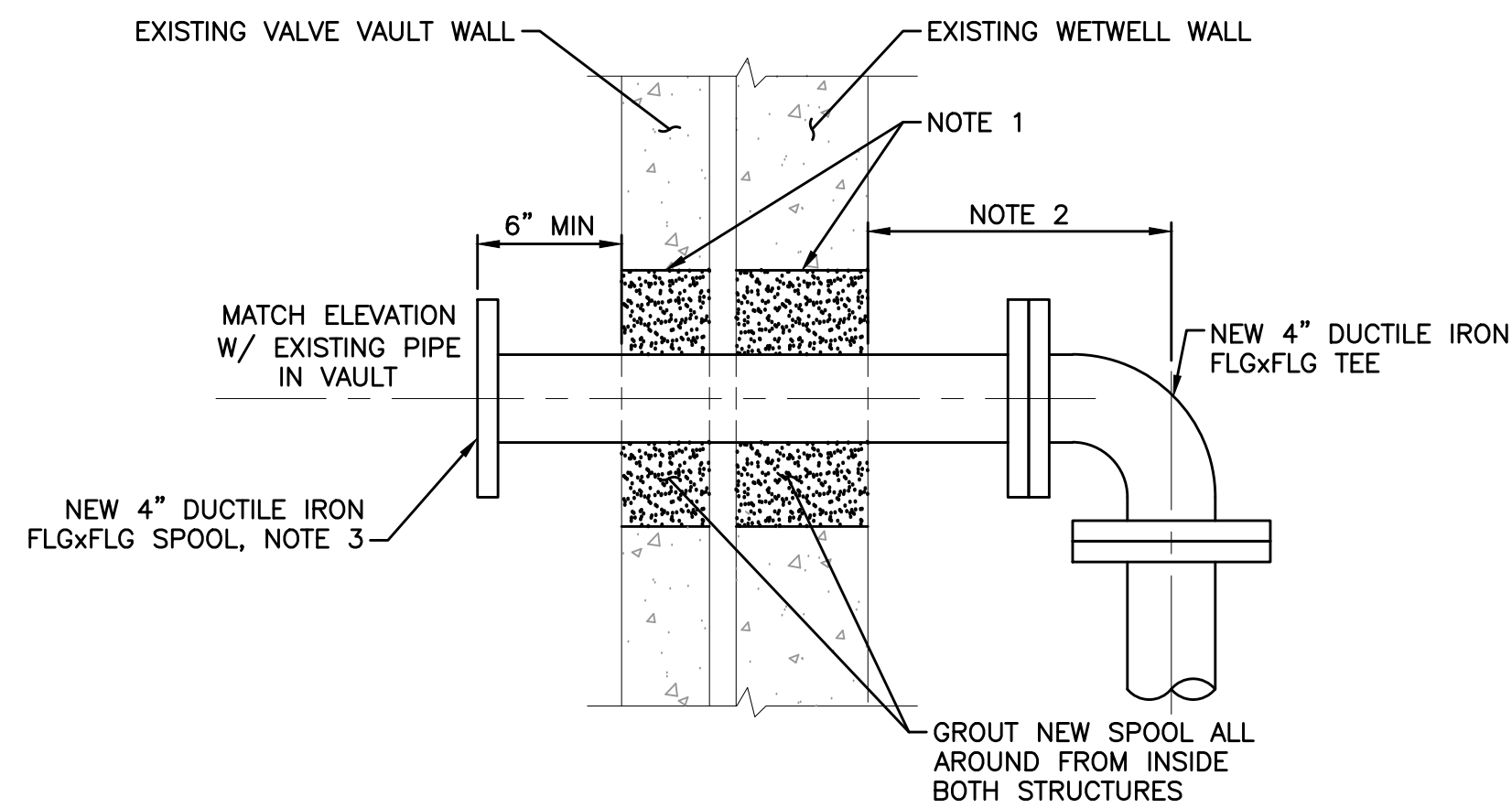

NOTES:

1. REMOVE EXISTING CONCRETE AND GROUT AS REQUIRED TO REMOVE EXISTING SPOOL.
2. NEW SPOOL LENGTH SHALL BE DETERMINED BY LOCATION OF VERTICAL DISCHARGE AT THE NEW PUMP AND NEW 90° FITTING.
3. THE NEW CHECK VALVE WILL BE INSTALLED AT THIS FLANGE. SEE DWG. C2 FOR OTHER VALVES AND SPOOLS.

WALL PENETRATION DETAIL 1
NTS

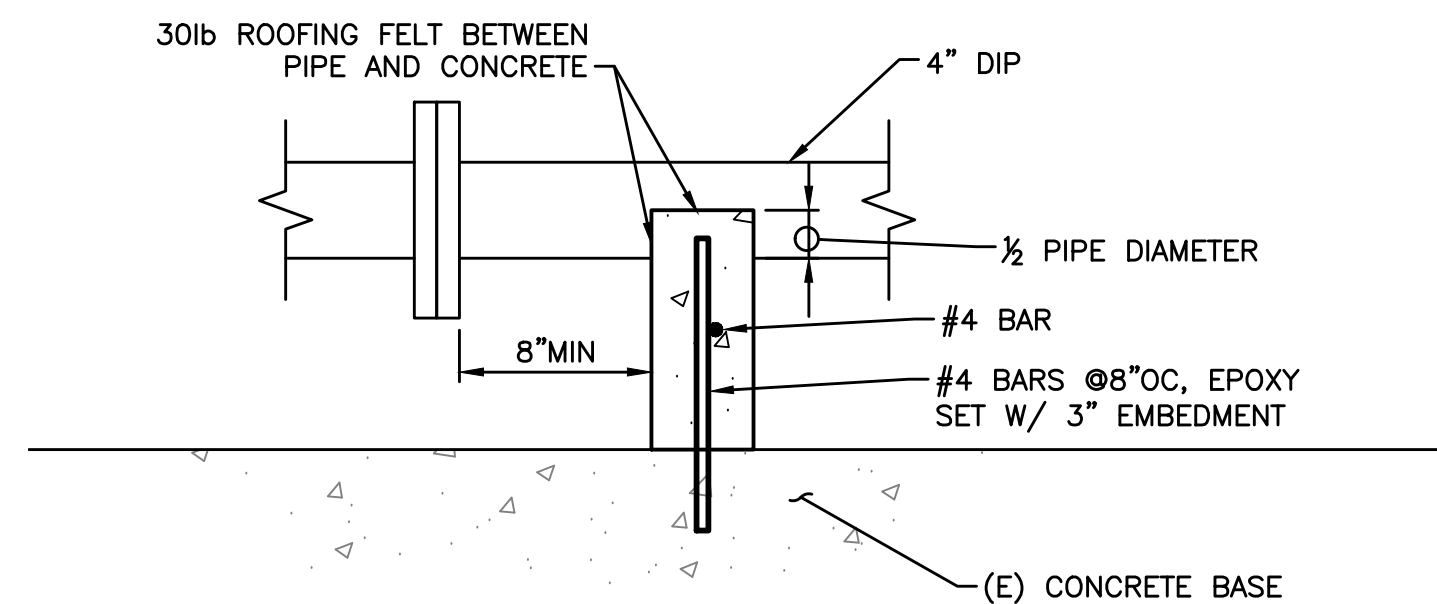

CONCRETE PIPE SUPPORT DETAIL 2
NTS

REVISIONS				
REV	DESCRIPTION	DATE	BY	CHKD

WARNING
0 1"
AT FULL SCALE
(IF BAR IS NOT 1" - SCALE ACCORDINGLY)

DESIGNED: D. HEIGHER
DRAWN: J. CADE
CHECKED: J. DOMENICHELLI
DATE: JUNE 2023

DOMENICHELLI & ASSOCIATES
Domenichelli & Associates
5180 Golden Foothill Pkwy, Suite 220 Ph: (916) 933-1997
El Dorado Hills, CA 95762 Fax: (916) 933-4778

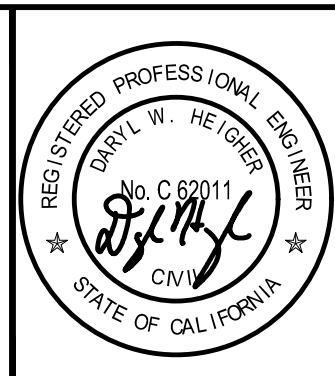

Rancho Murieta
Community Services District
15160 Jackson Road, Rancho Murieta
(916) 354 3700

RANCHO MURIETA COMMUNITY SERVICES
LIFT STATION 3B REHABILITATION

DETAILS

DRAWING NUMBER	C3
FILENAME	
RLWD FILE NO.	

1.2 BID

TO: Rancho Murieta Community Services District, 15160 Jackson Road, Rancho Murieta, CA 95683

The undersigned states and declares as follows:

That the Bidder has carefully examined the location of the proposed work; that the Bidder has examined the Contract Documents entitled: **Lift Station 3B Rehabilitation**; the Addenda Numbers 0 to 0, if any; that the Bidder has read the accompanying Instructions to Bidders; that the Bidder hereby proposes to begin work and complete the project in accordance with the schedule and deadlines in the Contract Documents; that the Bidder hereby proposes to furnish all labor, materials, tools, and equipment, and to perform all work required, complete in place, in compliance with all terms and condition and requirements of the Contract Documents; and that the Bidder will take in full payment for the work the prices set forth in the accompanying bid schedule.

The Bidder acknowledges that the following quantities are approximate only, being given as a basis for the comparison of proposals, that the District does not expressly or by implication agree that the actual amount of the work will correspond therewith, and that the District reserves the right to increase or decrease the amount of any class or portion of the work, as may be deemed necessary or advisable by the Engineer.

The following surety or sureties have agreed to furnish payment and faithful performance bonds to the Bidder if it is awarded the contract:

Name of Performance Bond Surety: Epic Brokers - Travelers

Name of Payment Bond Surety: Epic Brokers - Travelers

BIDDER INFORMATION

Bidder Name: TNT Industrial Contractors Inc

Type of Business Entity and State of Incorporation (e.g., corporation, limited liability company, partnership):

Corporation - California

Contractor's License No.: 622974

DIR Public Works Contractor Registration No.: 1000000573

Expiration Date: 6/30/2025

Type of license: A,B

Name under which license is held: TNT Industrial Contractors Inc - Joshua Twist

Status of license: Current and Active

The Bidder's authorized officer identified below hereby declares that the representations in this Bid are true and correct and of my own personal knowledge, and that these representations are made under penalty of perjury under the laws of the State of California.

Authorized Signature:  _____

Printed Name: Joshua Twist

Title: President

Date: July 13, 2023

Address: 3800 Happy Lane, Sacramento, CA 95827

Phone: 916-395-8400

Fax: 916-395-8429

Email: jtwist@tntindustrial.com

1.3 BID SCHEDULE

Item No.	Description	Unit (e.g., Lump Sum, Per Hour)	Amount (\$)
1	Mobilization/Demobilization	LS	9,072
2	Worker Safety/Shoring	LS	11,261
3	Bypass Pumping	LS	43,740
4	Demolition	LS	19,464
5	Grout Patching/Replacement	LS	9,568
6	Piping & Valves	LS	40,633
7	Pump Installation	LS	2,769
8	Testing	LS	4,827
	Total Lump Sum Price:		\$ 141,334

Acknowledge Addenda

Addendum #: _____ Signed: _____

Addendum #: _____ Signed: _____

Addendum #: _____ Signed: _____

Addendum #: _____ Signed: _____

1.4 DESIGNATION OF SUBCONTRACTORS

In compliance with Public Contract Code section 4100 et seq. each bidder shall set forth below the: (a) name, location of the mill, shop, or office, and California contractor's license number of each subcontractor who will perform work or labor or render service to the Contractor in or about the construction of the work or improvement to be performed under these specifications in excess of one-half of 1% of the Contractor's total bid, (b) description of the type of work to be performed by each such subcontractor, and (c) portion of the work (expressed in dollar amount) that will be performed by each such subcontractor.

If the Contractor fails to specify a subcontractor for any portion of the work to be performed under the Contract, it shall be deemed to have agreed to perform such portion itself, and it shall not be permitted to subcontract that portion of the work except under the conditions hereinafter set forth.

Subletting or subcontracting of any portion of the work in excess of one-half of 1% of the Contractor's total bid as to which no subcontractor was designated in the original bid shall only be permitted in cases of public emergency or necessity, and then only after a making a written finding as a public record of the District setting forth the facts constituting the emergency or necessity.

Subcontractor (name, address, Subcontractor's CSLB License Number, Subcontractor's DIR Public Works Contractor Registration Number)	Description of Subcontractor Work	Portion of Work (\$)
Mason Painting P.O. Box 1115 Orangevale, CA CA Lic # 819987 DIR - 100008947	Painting	\$ 6,000

Subcontractor (name, address, Subcontractor's CSLB License Number, Subcontractor's DIR Public Works Contractor Registration Number)	Description of Subcontractor Work	Portion of Work (\$)

Additional pages attached: _____

1.5 BID BOND

KNOW ALL MEN BY THESE PRESENTS, THAT WE, THE UNDERSIGNED
TNT Industrial Contractors, Inc. _____, Contractor as Principal; and
Travelers Casualty and Surety Company of America _____, as Surety, are hereby held and bound
unto Rancho Murieta Community Services District, hereinafter called the District, in the sum of
\$ Not to exceed ten percent of the bid amount***** (not to exceed 10% of the bid amount), which sum is equal to at least ten
percent of the total amount of the Bid, payment of which sum, well and truly to be made, we hereby
jointly and severally bind ourselves, our heirs, executors, administrators, successors, and assigns.

The condition of the above obligation is such that whereas the Principal has submitted to
the District a certain Bid, attached hereto and hereby made a part hereof, to enter into a Contract
in writing, for the construction of the following public works project:

Lift Station 3B Rehabilitation. This project will include demolition of existing
station components, grout placement, replacement of the submersible sewage
pumps, piping, valves, and check valves for this station. In addition, the Contractor
will be responsible for intercepting and pumping incoming sewage around the
worksite as required.

NOW, THEREFORE,

(a) If the Bid is rejected, or in the alternate,

(b) If the Bid is accepted and the Principal shall sign and deliver a Contract, in the form
of the Contract attached hereto and shall execute and deliver Performance and Payment Bonds in
the forms attached hereto and shall deliver proof of insurance (all completed in accordance with
the Contract Documents), and shall in all other respects perform the agreement created by the
acceptance of the Bid;

Then, this obligation shall be void, otherwise the same shall remain in force and effect; it
being expressly understood and agreed that the liability of the Surety for any and all default of the
Principal hereunder shall be the amount of this obligation as herein stated.

The Surety, for value received, hereby stipulates and agrees that the obligations of said
Surety and its bond shall be in no way impaired or affected by any extension of the time within
which the District may accept such Bid, and said Surety does hereby waive notice of any such
extension.

IN WITNESS THEREOF, the above bounded parties have executed this instrument under
their several seals this 10th day of July, 2023, the
name and corporate seal of each corporate party being hereto affixed and those presents duly
signed by its undersigned representative, pursuant to authority of its governing body.

For Contractor as Principal:

TNT Industrial Contractors, Inc.

By: 
Name: Joshua Twist

Title: President

For Surety:

Travelers Casualty and Surety Company of America

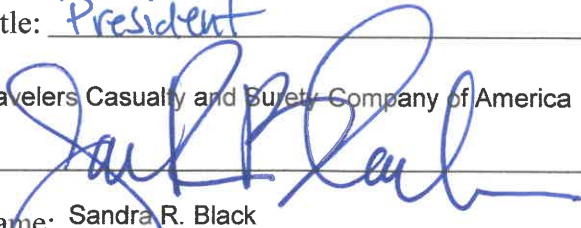
By: 
Name: Sandra R. Black
Title: Attorney-in-Fact

(Seal)

CALIFORNIA ALL-PURPOSE ACKNOWLEDGMENT

A notary public or other officer completing this certificate verifies only the identity of the individual who signed the document to which this certificate is attached, and not the truthfulness, accuracy, or validity of that document.

STATE OF CALIFORNIA

County of Sacramento }

On 7/10/2023 before me, E. Johnson, Notary Public,
Date Insert Name of Notary exactly as it appears on the official seal

personally appeared Sandra R. Black

Name(s) of Signer(s)



Place Notary Seal Above

who proved to me on the basis of satisfactory evidence to be the person(s) whose name(s) is/are subscribed to the within instrument and acknowledged to me that he/she/they executed the same in his/her/their authorized capacity(ies), and that by his/her/their signature(s) on the instrument the person(s), or the entity upon behalf of which the person(s) acted, executed the instrument.

I certify under PENALTY OF PERJURY under the laws of the State of California that the foregoing paragraph is true and correct.

Witness my hand and official seal.

Signature

Signature of Notary Public

OPTIONAL

Though the information below is not required by law, it may prove valuable to persons relying on the document and could prevent fraudulent removal and reattachment of the form to another document.

Description of Attached Document

Title or Type of Document: _____

Document Date: _____ Number of Pages: _____

Signer(s) Other Than Named Above: _____

Capacity(ies) Claimed by Signer(s)

Signer's Name: Sandra R. Black

- Individual
- Corporate Officer — Title(s): _____
- Partner Limited General
- Attorney in Fact
- Trustee
- Guardian or Conservator
- Other: _____

RIGHT THUMBPRINT
OF SIGNER

Top of thumb here

Signer is Representing:
Travelers Casualty and
Surety Company of America

Signer's Name: _____

- Individual
- Corporate Officer — Title(s): _____
- Partner Limited General
- Attorney in Fact
- Trustee
- Guardian or Conservator
- Other: _____

RIGHT THUMBPRINT
OF SIGNER

Top of thumb here

Signer is Representing:



**Travelers Casualty and Surety Company of America
Travelers Casualty and Surety Company
St. Paul Fire and Marine Insurance Company**

POWER OF ATTORNEY

KNOW ALL MEN BY THESE PRESENTS: That Travelers Casualty and Surety Company of America, Travelers Casualty and Surety Company, and St. Paul Fire and Marine Insurance Company are corporations duly organized under the laws of the State of Connecticut (herein collectively called the "Companies"), and that the Companies do hereby make, constitute and appoint **Sandra R Black** of **CONCORD, California**, their true and lawful Attorney(s)-in-Fact to sign, execute, seal and acknowledge any and all bonds, recognizances, conditional undertakings and other writings obligatory in the nature thereof on behalf of the Companies in their business of guaranteeing the fidelity of persons, guaranteeing the performance of contracts and executing or guaranteeing bonds and undertakings required or permitted in any actions or proceedings allowed by law.

IN WITNESS WHEREOF, the Companies have caused this instrument to be signed, and their corporate seals to be hereto affixed, this **21st** day of **April, 2021**.



State of Connecticut

City of Hartford ss.

By: 
Robert L. Raney, Senior Vice President

On this the **21st** day of **April, 2021**, before me personally appeared **Robert L. Raney**, who acknowledged himself to be the Senior Vice President of each of the Companies, and that he, as such, being authorized so to do, executed the foregoing instrument for the purposes therein contained by signing on behalf of said Companies by himself as a duly authorized officer.

IN WITNESS WHEREOF, I hereunto set my hand and official seal.

My Commission expires the **30th** day of **June, 2026**

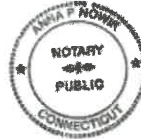

Anna P. Nowik, Notary Public

This Power of Attorney is granted under and by the authority of the following resolutions adopted by the Boards of Directors of each of the Companies, which resolutions are now in full force and effect, reading as follows:

RESOLVED, that the Chairman, the President, any Vice Chairman, any Executive Vice President, any Senior Vice President, any Vice President, any Second Vice President, the Treasurer, any Assistant Treasurer, the Corporate Secretary or any Assistant Secretary may appoint Attorneys-in-Fact and Agents to act for and on behalf of the Company and may give such appointee such authority as his or her certificate of authority may prescribe to sign with the Company's name and seal with the Company's seal bonds, recognizances, contracts of indemnity, and other writings obligatory in the nature of a bond, recognizance, or conditional undertaking, and any of said officers or the Board of Directors at any time may remove any such appointee and revoke the power given him or her; and it is

FURTHER RESOLVED, that the Chairman, the President, any Vice Chairman, any Executive Vice President, any Senior Vice President or any Vice President may delegate all or any part of the foregoing authority to one or more officers or employees of this Company, provided that each such delegation is in writing and a copy thereof is filed in the office of the Secretary; and it is

FURTHER RESOLVED, that any bond, recognizance, contract of indemnity, or writing obligatory in the nature of a bond, recognizance, or conditional undertaking shall be valid and binding upon the Company when (a) signed by the President, any Vice Chairman, any Executive Vice President, any Senior Vice President or any Vice President, any Second Vice President, the Treasurer, any Assistant Treasurer, the Corporate Secretary or any Assistant Secretary and duly attested and sealed with the Company's seal by a Secretary or Assistant Secretary; or (b) duly executed (under seal, if required) by one or more Attorneys-in-Fact and Agents pursuant to the power prescribed in his or her certificate or their certificates of authority or by one or more Company officers pursuant to a written delegation of authority; and it is

FURTHER RESOLVED, that the signature of each of the following officers: President, any Executive Vice President, any Senior Vice President, any Vice President, any Assistant Vice President, any Secretary, any Assistant Secretary, and the seal of the Company may be affixed by facsimile to any Power of Attorney or to any certificate relating thereto appointing Resident Vice Presidents, Resident Assistant Secretaries or Attorneys-in-Fact for purposes only of executing and attesting bonds and undertakings and other writings obligatory in the nature thereof, and any such Power of Attorney or certificate bearing such facsimile signature or facsimile seal shall be valid and binding upon the Company and any such power so executed and certified by such facsimile signature and facsimile seal shall be valid and binding on the Company in the future with respect to any bond or understanding to which it is attached.

I, **Kevin E. Hughes**, the undersigned, Assistant Secretary of each of the Companies, do hereby certify that the above and foregoing is a true and correct copy of the Power of Attorney executed by said Companies, which remains in full force and effect.

Dated this **10** day of **July**, **2023**.



Kevin E. Hughes, Assistant Secretary

**To verify the authenticity of this Power of Attorney, please call us at 1-800-421-3880.
Please refer to the above-named Attorney(s)-in-Fact and the details of the bond to which this Power of Attorney is attached.**

1.6 EXPERIENCE QUALIFICATIONS

The Bidder has been engaged in the contracting business, under the present business name for 32 years. Experience in work of a nature similar to that covered in the Bid extends over a period of 32 years.

The Bidder, as a contractor, has never failed to satisfactorily complete a contract awarded to it, except as follows:

None

The following contracts have been satisfactorily completed in the last three years for the persons, firm or entity indicated:

Year	Owner	Type of Work	Contract Amount
2023	California Department of Corrections	Bar screen & Compactor replacements	\$717,143.00
2023	Sewer Authority mid-coast	Barscreen repl	\$104,968
2023	Indian Valley CSD	Lift station rehab	\$24,952
2023	City of Manteca	Food waste processing facility	\$395,500
2023	City of Stockton	Bioscrubber repairs	\$623,135
2022	Tahoe City PUD	Lift station storage & bypass ports	\$620,855
2022	Aerojetrocketdyne	HDPE pipeline & Valves	\$449,450

The following is a list of plant and equipment owned by the Bidder, which is definitely available for use on the proposed work as required.

Quantity	Name, Type, and Capacity	Condition	Location
1	7.5 ton boom truck National Crane	Good	Sacramento, CA
1	12K telehandler, JLG	Good	Sacramento, CA
1	6K Telehandler Genie	Good	Sacramento, CA
1	Terex Backhoe 760B	Good	Sacramento, CA
1	Takeuch Excavator TB235B	Good	Sacramento, CA
1	Takeuch Excavator TB285	Good	Sacramento, CA
1	Takeuchi Skid Steer TL8 with sweeper	Good	Sacramento, CA
4	500 gallon water trailer	Good	Sacramento, CA

Executed on July 13, 2023, at Sacramento, California

BIDDER

Company Name: TNT Industrial Contractors Inc

Authorized Signature: 

Printed Name: Joshua Twist

Title: President

**1.7 NONCOLLUSION DECLARATION TO BE EXECUTED BY
BIDDER AND SUBMITTED WITH BID (PUBLIC CONTRACT CODE SECTION 7106)**

The undersigned declares:

I am the President (Title)
of TNT Industrial Contractors Inc (Bidder), the
party making the foregoing bid.

The bid is not made in the interest of, or on behalf of, any undisclosed person, partnership, company, association, organization, or corporation. The bid is genuine and not collusive or sham. The bidder has not directly or indirectly induced or solicited any other bidder to put in a false or sham bid. The bidder has not directly or indirectly colluded, conspired, connived, or agreed with any bidder or anyone else to put in a sham bid, or to refrain from bidding. The bidder has not in any manner, directly or indirectly, sought by agreement, communication, or conference with anyone to fix the bid price of the bidder or any other bidder, or to fix any overhead, profit, or cost element of the bid price, or of that of any other bidder. All statements contained in the bid are true. The bidder has not, directly or indirectly, submitted his or her bid price or any breakdown thereof, or the contents thereof, or divulged information or data relative thereto, to any corporation, partnership, company, association, organization, bid depository, or to any member or agent thereof, to effectuate a collusive or sham bid, and has not paid, and will not pay, any person or entity for such purpose.

Any person executing this declaration on behalf of a bidder that is a corporation, partnership, joint venture, limited liability company, limited liability partnership, or any other entity, hereby represents that he or she has full power to execute, and does execute, this declaration on behalf of the bidder.

I declare under penalty of perjury under the laws of the State of California that the foregoing is true and correct and that this declaration is executed on July 13, 2023
at Sacramento, CA.

Authorized Signature: 

Printed Name: Joshua Twist

1.8 ACKNOWLEDGMENT OF INSURANCE REQUIREMENTS

By signing below Bidder acknowledges the insurance requirements as listed in the General Conditions, section 5.52 "Insurance". By this acknowledgment, the Bidder and its insurance provider(s) and surety(ies) certify that they have read and understand the insurance and bonding requirements in their entirety, including limits of coverage, additional insureds and endorsements, and bonding requirements, and that the Bidder can provide the insurance coverage and bonds as required in the Contract documents without exception.

Bidder understands that if the insurance coverage provided in section 5.52 of the General Conditions and the Contract Bonds cannot be provided, its bid is subject to rejection by the District as non-responsive.

BIDDER

Company Name: TNT Industrial Contractors, Inc.

Authorized Signature: 

Printed Name: Joshua Twist

Title: President

Date: July 13, 2023

INSURANCE PROVIDER/SURETY REPRESENTATIVE

Insurer/Surety Name: Travelers Casualty and Surety Company of America

Authorized Signature: 

Printed Name: Sandra R. Black

Title: Attorney-in-Fact

Date: July 13, 2023

Bidder Must Provide This Acknowledgment for Each Insurer or Surety Providing Insurance Coverage or a Bond under this Contract

1.9 IRAN CONTRACTING ACT CERTIFICATION

Pursuant to Public Contract Code (PCC) section 2204, the following Iran Contracting Act certification is required if your bid totals \$1,000,000 or more.

If your bid totals \$1,000,000 or more, you must complete only one of the following two paragraphs. To complete paragraph 1, check the corresponding box and complete the certification. To complete paragraph 2, simply check the corresponding box.

1. We are not on the current list of persons engaged in investment activities in Iran created by the California Department of General Services (DGS) pursuant to PCC 2203(b), and we are not a financial institution extending twenty million dollars (\$20,000,000) or more in credit to another person, for 45 days or more, if that other person will use the credit to provide goods or services in the energy sector in Iran and is identified on the current list of persons engaged in investment activities in Iran created by DGS.

I declare under penalty of perjury under the laws of the State of California that the foregoing is true and correct and that this declaration is executed on

July 13, 2023 _____ (date),

at Sacramento _____ (city), California _____ (state).

 _____ (signature)

Joshua Twist _____ (printed name)

OR

2. We have received written permission from the District to submit a bid pursuant to PCC 2203(c) or (d). A copy of the written permission from the District is included with our bid.



tnt@tntindustrial.com, www.tntindustrial.com
3600 51st Avenue, Sacramento, CA 95823
916-395-8400, fax 916-395-8429
Contractor's License No. 622974

RESOLUTION OF BOARD OF DIRECTORS OF
TNT INDUSTRIAL CONTRACTORS, INC.

RESOLVED, That estimates of the cost of all work on which propositions by this Corporation may be submitted shall be prepared by the President or the Secretary, or by some person specifically appointed by either of them, and, when completed, shall be entered by the Secretary in a book kept expressly for that purpose, and no proposition shall be submitted by this Corporation until such estimate has been prepared and checked by or submitted to the President or the Secretary, and

RESOLVED FURTHER, That all orders for material shall be given in writing, by the President and the Secretary, or by either one of them acting with the consent of the other, and that no order shall be valid except when signed by the President or the Secretary. Copies of all orders for material shall be preserved in a book kept expressly for that purpose, and

RESOLVED FURTHER, That all contracts for the performance of work shall be valid and binding on the Corporation only when signed by the President or the Vice President, and by the Treasurer or the Secretary.

I, Joshua Twist, do hereby certify that I am duly elected and qualified Secretary and the keeper of the records and corporate seal of TNT INDUSTRIAL CONTRACTORS, INC., a corporation organized and existing under the laws of the State of CALIFORNIA, and that the above is a true and correct copy of a resolution duly adopted at a meeting of the Board of Directors thereof, convened and held in accordance with the law and the Bylaws of said Corporation on OCTOBER 20, 2014, and that such resolution is now in full force and effect.

IN WITNESS WHEREOF, I have affixed my name as Secretary and have caused the corporate seal of said Corporation to be hereunto affixed, this 20th day of OCTOBER, 2014.

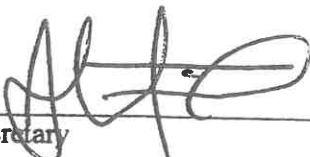
Secretary

MEMORANDUM

Date: July 19, 2023
To: Board of Directors
From: Michael Fritschi, P.E. – Operations Director
Subject: Proposal for Capital Improvement Planning and Wastewater Rate Study Consulting Services

Proposed Action

Direct staff to enter into a contract with the team of Lumos & Associates and Hansfield Economic Consulting, LLC in the amount of \$159,437 to perform the District Capital Improvements Planning and 5-year Rate Study.

Background

An RFP for the capital improvements planning and 5-year rate study was released on May 25, 2023 with an original due date of June 26, 2023. The RFP contained a statement that either the CIP or Rate Study could be submitted on separately. The District initially posted the copy of the RFP to the CSDA and District website and sent directly to the following (19) firms:

- Dudek
- West Yost & Associates
- GHD
- Domenichelli & Associates
- Adkins Engineering
- HDR
- SHN
- Maddaus Water
- Water Works Engineers
- Infrastructure Improvement, INC
- Murray Smith
- Carollo
- Lumos & Associates
- Brown & Caldwell
- RFE Engineering
- Black & Veatch
- APS Environmental
- SNG Associates
- Dewberry

On June 26, 2023 the District had received a single proposal from Team of Lumos & Associates and Hansfield Economic Consulting LLC. The proposal was reviewed by staff. The team shows good expertise and relevant experience by Firm and by assigned Firm Personnel. There is also an extensive list of recent similar projects for similar sized utilities within the Northern California area. The proposed time and materials estimate submitted to complete the work was proposed at \$159,437, well under the allocated CIP budget.

On June 27th, staff was directed to provide an extension to the original due date to July 12th, 2023. A notice was sent to the original (18) firms contacted (with the exception of Lumos & Associates) and updates were posted to the CSDA and District website. Staff conversed with some of the firms to discuss any potential interest and while many firms expressed some initial interest, some firms expressed that they were busy or that it was difficult to locate the appropriate sub-consultant.

The District did not receive any additional RFP responses after the July 12th time extension. Currently the District is in the process of contacting references for the Lumos/Hansford team and have received very positive reviews from (3) of the references thus far.

Recommended Action

Direct staff to enter into a contract with the team of Lumos & Associates and Hansfield Economic Consulting, LLC in the amount of \$159,437 to perform the District Capital Improvements Planning and 5-year Rate Study.

MEMORANDUM

Date: July 19, 2023
To: Board of Directors
From: Michael Fritschi, P.E. – Operations Director
Subject: Membrane Expenditure

Action

Staff have ordered a set of (15) replacement membrane modules.

Background

The District Water Treatment Plant (WTP) utilizes 6 cassettes of membranes to strain impurities prior to disinfection. Many of the original membranes are still in operation from the 2015 installation. Plant staff typically replace several membranes on an annual basis and the District budgets for this replacement. Plant staff have identified membranes in need of replacement due to age and the beginning of cracked distributors and decreased performance. The cost to provide a set of (15) membrane modules is \$28,664.44 or \$1,910.96 per module compared with \$2,490.83 per module when the District purchases (5) modules.

The District has (3) trains of membranes at the WTP with (2) cassettes per train. Each cassette contains 87 modules of membranes. Staff keeps a membrane map of each module in each cassette that track which modules have been repaired or replaced and when that action has taken place along with the serial number.

The life span for a membrane is 7-10 years. The District has performed at least one repair on approximately 291 modules out of the 522 modules (56%) that were installed in 2015. Once a module has had repairs on over 20% of the membranes in that module, the module requires replacement.

This is a sole source procurement as these are proprietary membranes and the only membranes that fit this system. Proprietary membrane brand installations are a very common occurrence in the water/wastewater membrane business.

Recommended Action

Staff recommend the Board authorize the purchase of 15 membrane modules to replace the ones that are in need of replacement at the Water Treatment Plant for a cost of \$28,664.44.

		ZENON ENVIRONMENTAL CORPORATION 3239 DUNDAS STREET WEST OAKVILLE, ON L6M 4B2 PHONE: 1-866-439-2837 FAX: 866-891-4893 (ORDER PLACEMENT)			<h1>Quotation</h1>		
		Quote Date		Quotation Exp. Date			
06JUL2023		03AUG2023		20585479			
Sales Org.		Sales Representative / Contact			Reference		
B493		Jason Diamond					
Sold To: 1000129822 RANCHO MURIETA COMMUNITY SERVICES DISTRICT 15160 JACKSON ROAD RANCHO MURIETA CA 95683-0000 UNITED STATES				Ship To: 4000167443 RANCHO MURIETA COMMUNITY SERVICES DISTRICT 15160 JACKSON ROAD RANCHO MURIETA CA 95698-0000 UNITED STATES			
Bill To: 0000487137 RANCHO MURIETA COMMUNITY SERVICES DISTRICT ATTN: ACCOUNTS PAYABLE PO Box 1050 RANCHO MURIETA CA 95683-1050 UNITED STATES				Payment Terms			
				Net 30 Days from Date of Receipt of Invoice			
				Inco Terms			
				DDP PLANT SITE			
Currency: U.S. Dollar				Freight: Freight Prepaid			
SNo.	Part Number / Item Description	Quantity	Unit	Price	Unit	Amount	
10	3134285 MOD/PKG-ZW1000,450,CPX,1M						
	15 EA	15	EA	1,298.45	EA	19,476.75	
20	3095534 FEE,FREIGHT/INSURANCE						
	1 EA	1	EA	7,250.00	EA	7,250.00	
30	3098956 O-RING,EPDM,-131						
	30 EA						
***** REQUEST FOR QUOTATION: Prepared By: Ernie Russell Veolia Commercial Operations, ZeeWeed Products PLEASE REFERENCE THIS QUOTATION NUMBER with your order to ensure correct pricing and on-time delivery. Please notify the contact above if changes to this quotation are needed. PLEASE PROVIDE REQUESTED DELIVERY DATE with your order.							

Thank you for your Consideration. To place an order, please fax signed Purchase Orders to the Customer Care number shown above. To ensure that you receive the pricing quoted, please reference this quotation number on your order. All sales are subject to our terms and conditions, contained with this quotation. Freight for Bulk Delivery and specialized freight charges, where applicable, are not included unless otherwise indicated above. Taxation rates shown are based on tax codes in effect at the time of this quotation, and are subject to change.

		ZENON ENVIRONMENTAL CORPORATION 3239 DUNDAS STREET WEST OAKVILLE, ON L6M 4B2 PHONE: 1-866-439-2837 FAX: 866-891-4893 (ORDER PLACEMENT)		Quotation		
Quote Date		Quotation Exp. Date		Veolia WTS Quote		
06JUL2023		03AUG2023		20585479		
Sales Org.		Sales Representative / Contact		Reference		
B493		Jason Diamond				
Sold To: 1000129822 RANCHO MURIETA COMMUNITY SERVICES DISTRICT 15160 JACKSON ROAD RANCHO MURIETA CA 95683-0000 UNITED STATES			Ship To: 4000167443 RANCHO MURIETA COMMUNITY SERVICES DISTRICT 15160 JACKSON ROAD RANCHO MURIETA CA 95698-0000 UNITED STATES			
Bill To: 0000487137 RANCHO MURIETA COMMUNITY SERVICES DISTRICT ATTN: ACCOUNTS PAYABLE PO Box 1050 RANCHO MURIETA CA 95683-1050 UNITED STATES			Payment Terms Net 30 Days from Date of Receipt of Invoice			
			Inco Terms DDP PLANT SITE			
Currency: U.S. Dollar			Freight: Freight Prepaid			
SNo.	Part Number / Item Description	Quantity	Unit	Price	Unit	Amount
	<p>AVAILABILITY / LEAD TIME: At the time of this quotation, there is no available product in inventory. Estimated lead time is 50-60 weeks, and exclusive of freight transit time.</p> <p>Availability is subject to change.</p> <p>ORDER PLACEMENT / ORDER STATUS: Please send your Purchase Order to:</p> <p>VEOLIA North America Customer Care Contacts: Tel: 1-866-439-2837 (Select Option 2) Email: csc.customequipment@veolia.com</p> <p>*Note: Minimum Order Value is \$100.00 *Note: please follow the PO guidelines in the covering email of this quote < OR ></p> <p>SELF-SERVICE - Visit our eStore @: www.estore.suezwatertechnologies.com</p> <p>For help with registration or existing order, please email: csc.digital@veolia.com</p> <p>*Note: No minimum order value required if using eStore</p> <p>SHIPPING POINT: Oakville, ON Canada L6M 4B2</p> <p>PAYMENT: VEOLIA prefers to receive payment by wire transfer and</p>					

Thank you for your Consideration. To place an order, please fax signed Purchase Orders to the Customer Care number shown above. To ensure that you receive the pricing quoted, please reference this quotation number on your order. All sales are subject to our terms and conditions, contained with this quotation. Freight for Bulk Delivery and specialized freight charges, where applicable, are not included unless otherwise indicated above. Taxation rates shown are based on tax codes in effect at the time of this quotation, and are subject to change.

		ZENON ENVIRONMENTAL CORPORATION 3239 DUNDAS STREET WEST OAKVILLE, ON L6M 4B2 PHONE: 1-866-439-2837 FAX: 866-891-4893 (ORDER PLACEMENT)			<h1>Quotation</h1>	
Quote Date		Quotation Exp. Date		Veolia WTS Quote		
06JUL2023		03AUG2023		20585479		
Sales Org.		Sales Representative / Contact		Reference		
B493		Jason Diamond				
Sold To: 1000129822 RANCHO MURIETA COMMUNITY SERVICES DISTRICT 15160 JACKSON ROAD RANCHO MURIETA CA 95683-0000 UNITED STATES				Ship To: 4000167443 RANCHO MURIETA COMMUNITY SERVICES DISTRICT 15160 JACKSON ROAD RANCHO MURIETA CA 95698-0000 UNITED STATES		
Bill To: 0000487137 RANCHO MURIETA COMMUNITY SERVICES DISTRICT ATTN: ACCOUNTS PAYABLE PO Box 1050 RANCHO MURIETA CA 95683-1050 UNITED STATES				Payment Terms		
				Net 30 Days from Date of Receipt of Invoice		
				Inco Terms		
				DDP PLANT SITE		
Currency: U.S. Dollar				Freight: Freight Prepaid		
SNo.	Part Number / Item Description	Quantity	Unit	Price	Unit	Amount
	<p>will also accept payment by courier check/cheque.</p> <p>Wire transfer information for #legal entity# send details to: SHD WATS REMIT-NAM vtc.vwts.remit-nam.all@veolia.com</p> <p>Bank of America Merrill Lynch C/O ZENON Environmental Corporation 901 Main Street Dallas, TX 75202 ACCT# 4426318136 ABA# 026009593 SWIFT# BOFAUS3N ACH# 111000012</p> <p>TERMS: All sales are subject to Veolia#s terms and conditions, contained within this quotation.</p> <p>Thank You! - We Appreciate Your Business! ***** VWTS would like to note that under the current exceptional circumstances across global supply chains and logistics networks, WTS may not be in a position to guarantee and comply with the planned schedule for product / project delivery or performance. VWTS reserves the right to modify the schedule / contract accordingly. VWTS will promptly inform you of any changes which may impact the contract or the project. ***** NOTES RELATED TO ZEEWEED MEMBRANES: DDP - Delivery will be by standard ocean/ground on the basis of DDP customer site</p>					

Thank you for your Consideration. To place an order, please fax signed Purchase Orders to the Customer Care number shown above. To ensure that you receive the pricing quoted, please reference this quotation number on your order. All sales are subject to our terms and conditions, contained with this quotation. Freight for Bulk Delivery and specialized freight charges, where applicable, are not included unless otherwise indicated above. Taxation rates shown are based on tax codes in effect at the time of this quotation, and are subject to change.

		ZENON ENVIRONMENTAL CORPORATION 3239 DUNDAS STREET WEST OAKVILLE, ON L6M 4B2 PHONE: 1-866-439-2837 FAX: 866-891-4893 (ORDER PLACEMENT)		Quotation		
Quote Date		Quotation Exp. Date		Veolia WTS Quote		
06JUL2023		03AUG2023		20585479		
Sales Org.		Sales Representative / Contact		Reference		
B493		Jason Diamond				
Sold To: 1000129822 RANCHO MURIETA COMMUNITY SERVICES DISTRICT 15160 JACKSON ROAD RANCHO MURIETA CA 95683-0000 UNITED STATES			Ship To: 4000167443 RANCHO MURIETA COMMUNITY SERVICES DISTRICT 15160 JACKSON ROAD RANCHO MURIETA CA 95698-0000 UNITED STATES			
Bill To: 0000487137 RANCHO MURIETA COMMUNITY SERVICES DISTRICT ATTN: ACCOUNTS PAYABLE PO Box 1050 RANCHO MURIETA CA 95683-1050 UNITED STATES			Payment Terms Net 30 Days from Date of Receipt of Invoice			
			Inco Terms DDP PLANT SITE			
Currency: U.S. Dollar			Freight: Freight Prepaid			
SNo.	Part Number / Item Description	Quantity	Unit	Price	Unit	Amount
	<p>Partial shipments will be acceptable unless otherwise specified. Due to varying origins and availability, non-membrane items included in this proposal may be shipped separately from the membranes. Should separate shipments be required, where possible, VEOLIA will strive to provide these items on or before the delivery of the membranes.</p> <p>ORIGIN - ZeeWeed membranes originate from the VEOLIA Water Technologies & Solutions, ZENON Membrane Products (ZEM), Bláthy Ottó u 4, Oroszlány, 2840 Hungary facility. Inbound freight from Hungary to Oakville has been included in the quote. Customer will arrange for pick up from origin.</p> <p>In the event an invoice is issued on shipment of goods from a VEOLIA Hungarian production facility, payment terms will be extended by an additional 45 days to account for the additional transit time to the delivery location.</p> <p>PRICE REVIEW: Notwithstanding the terms set forth herein or of any agreement or acceptance of Seller's quotation, Seller reserves the right at any time and from time to time by notice in writing to the Buyer to (a) determine periodic price reviews based on Goods raw material increase arising from currency devaluations (b) increase Prices (or impose temporary price adjustments) based on increases in the cost of base components for the Goods or Services provided, where the increase is due to increased global demand, limited supply, temporary</p>					

Thank you for your Consideration. To place an order, please fax signed Purchase Orders to the Customer Care number shown above. To ensure that you receive the pricing quoted, please reference this quotation number on your order. All sales are subject to our terms and conditions, contained with this quotation. Freight for Bulk Delivery and specialized freight charges, where applicable, are not included unless otherwise indicated above. Taxation rates shown are based on tax codes in effect at the time of this quotation, and are subject to change.

		ZENON ENVIRONMENTAL CORPORATION 3239 DUNDAS STREET WEST OAKVILLE, ON L6M 4B2 PHONE: 1-866-439-2837 FAX: 866-891-4893 (ORDER PLACEMENT)			Quotation		
Quote Date		Quotation Exp. Date			Veolia WTS Quote		
06JUL2023		03AUG2023			20585479		
Sales Org.		Sales Representative / Contact			Reference		
B493		Jason Diamond					
Sold To: 1000129822 RANCHO MURIETA COMMUNITY SERVICES DISTRICT 15160 JACKSON ROAD RANCHO MURIETA CA 95683-0000 UNITED STATES				Ship To: 4000167443 RANCHO MURIETA COMMUNITY SERVICES DISTRICT 15160 JACKSON ROAD RANCHO MURIETA CA 95698-0000 UNITED STATES			
Bill To: 0000487137 RANCHO MURIETA COMMUNITY SERVICES DISTRICT ATTN: ACCOUNTS PAYABLE PO Box 1050 RANCHO MURIETA CA 95683-1050 UNITED STATES				Payment Terms Net 30 Days from Date of Receipt of Invoice			
				Inco Terms DDP PLANT SITE			
Currency: U.S. Dollar				Freight: Freight Prepaid			
SNo.	Part Number / Item Description	Quantity	Unit	Price	Unit	Amount	
	<p>product shortages, allocation of supply, or such other similar inflationary pressures; and (c) impose a surcharge equal to any increase in the cost of the Goods or Services as a result of a modification of exchange rates, duties, taxes or other levies imposed by public authorities.</p> <p>SHIPMENT/ COLLECTION DELAYS: The membrane/equipment sale will be subject to price adjustment if not collected within 1 month of readiness for Shipment. After the one month of Readiness for Shipment if Purchaser does not send his agreement to receive or collects the membrane/equipment (depending on Incoterms), Seller is entitled to reallocate the membrane/ equipment to another customer. The corresponding down payment previously paid by Purchaser will be, at Purchaser choice, returned to Purchaser minus the administrative costs incurred by Seller, or will be assigned to the down payment of a new order for membrane/equipment at market price. New lead time will be confirmed once new order is received.</p> <p>TEMPERATURE - UF membranes cannot be allowed to freeze or overheat and may require temperature-controlled freight and handling according to the season and the planned routing. If required, the price of temperature control will be included within the firm quote on freight by VEOLIA.</p> <p>UNLOADING - may require one of or a combination of a pump truck, loading dock, extended forks and an experienced fork lift driver at delivery destination.</p>						

Thank you for your Consideration. To place an order, please fax signed Purchase Orders to the Customer Care number shown above. To ensure that you receive the pricing quoted, please reference this quotation number on your order. All sales are subject to our terms and conditions, contained with this quotation. Freight for Bulk Delivery and specialized freight charges, where applicable, are not included unless otherwise indicated above. Taxation rates shown are based on tax codes in effect at the time of this quotation, and are subject to change.

	ZENON ENVIRONMENTAL CORPORATION 3239 DUNDAS STREET WEST OAKVILLE, ON L6M 4B2 PHONE: 1-866-439-2837 FAX: 866-891-4893 (ORDER PLACEMENT)	<h1 style="margin: 0;">Quotation</h1>
---	--	---------------------------------------

Quote Date	Quotation Exp. Date	Veolia WTS Quote
06JUL2023	03AUG2023	20585479
Sales Org.	Sales Representative / Contact	Reference
B493	Jason Diamond	

Sold To: 1000129822 RANCHO MURIETA COMMUNITY SERVICES DISTRICT 15160 JACKSON ROAD RANCHO MURIETA CA 95683-0000 UNITED STATES	Ship To: 4000167443 RANCHO MURIETA COMMUNITY SERVICES DISTRICT 15160 JACKSON ROAD RANCHO MURIETA CA 95698-0000 UNITED STATES
--	--

Bill To: 0000487137 RANCHO MURIETA COMMUNITY SERVICES DISTRICT ATTN: ACCOUNTS PAYABLE PO Box 1050 RANCHO MURIETA CA 95683-1050 UNITED STATES	Payment Terms Net 30 Days from Date of Receipt of Invoice
	Inco Terms DDP PLANT SITE

Currency: U.S. Dollar	Freight: Freight Prepaid
------------------------------	---------------------------------

SNo.	Part Number / Item Description	Quantity	Unit	Price	Unit	Amount
	EXPORT DOCUMENTS - All ZeeWeed membrane module shipments into the USA require clearance documentation from the EPA. VEOLIA will prepare and provide the required EPA documentation to the Carrier. MPF - Merchandise processing fee is a fee assessed for formal custom entries based on 0.35% of the invoice value, with a minimum of USD \$25 per formal entry and a maximum of USD \$485. On the basis of DDP terms, this fee will be paid by VEOLIA within the quoted price. On the basis of FCA terms, this fee will be the responsibility of the Buyer. DUTY - A US Customs duty of 3.9% applies to all ZeeWeed membranes shipped individually or in shipping frames; not in operational cassette frames. On the basis of DDP terms, this duty will be paid by VEOLIA within the quoted price. On the basis of FCA terms, this duty will be paid by the Buyer. Any new duty imposed after the date of this proposal is the responsibility of Buyer. Due to varying origins and availability, non-membrane items included in this proposal may be shipped separately from the membranes. Should separate shipments be required, where possible, VEOLIA will strive to provide these items on or before the delivery of the membranes. *****					

SALES DISCOUNT	USD	0.00
NET PRICE	USD	26,726.75
STATE TAX	6.00%	1,603.60
COUNTY TAX	1.25%	334.09
TOTAL AMOUNT		28,664.44

Thank you for your Consideration. To place an order, please fax signed Purchase Orders to the Customer Care number shown above. To ensure that you receive the pricing quoted, please reference this quotation number on your order. All sales are subject to our terms and conditions, contained with this quotation. Freight for Bulk Delivery and specialized freight charges, where applicable, are not included unless otherwise indicated above. Taxation rates shown are based on tax codes in effect at the time of this quotation, and are subject to change.

Veolia Water Technologies & Solutions

Terms & Conditions of Sale

1. **Exclusive Terms and Conditions.** Together with any other terms the parties agree to in writing, these Terms and Conditions of Sale form the exclusive terms ("Agreement") where by Buyer agrees to purchase, and sell Goods and provide advice, instruction and other services in connection with the sale of those Goods ("Services"). Notwithstanding any provision communicated in any way by Buyer to Seller prior to this Agreement including any terms contained in any request for quote by Buyer, Buyer agrees that this Agreement will control the relationship by accepting Goods and Services from Seller, even if Buyer sends to Seller other terms and conditions to which Seller may not respond.
2. **Buyer Obligations.** Seller will not control the actual operation of either Buyer's systems or Goods at the site, and unless otherwise specifically agreed in writing, installation of Goods shall be the responsibility of Buyer. Goods and Services provided hereunder are based upon the information Buyer makes available to Seller, and Seller reserves the right to utilize the most compact and feasible design compatible with sound engineering practices, and to make changes in details of design, construction and arrangement of Goods unless precluded by limitations (including, but not limited to actual space and feedwater/substance quality specifications) specified by Buyer in writing at the time an order is placed. If no such limitations are specified, Seller shall not be held responsible for incompatibility of the Goods and Services due to changes in feedwater/substance quality specifications or site conditions nor for incompatibility with actual space or design limitations, which were not initially disclosed by Buyer and become apparent at a later date. For Services to be accurate and Goods to work as intended, Buyer must fulfill the following obligations ("Obligations"): (a) provide Seller complete and accurate information and data relevant to the scope of work to be provided, such as information related to Buyer's site conditions, systems, related equipment and process, feedwater or other substances to be treated or measured with the Goods, including any hidden, unapparent, or changing conditions that may affect the effectiveness of the Goods; (b) operate all related systems and the Goods within the agreed to control parameters or, if none, within industry customary operating conditions; (c) maintain all related systems and Goods in good operating condition and repair; and (d) maintain and handle Goods in a proper and safe manner. If Buyer fails to fulfill the foregoing Obligations, Seller shall be relieved of any obligations with respect to warranties or any other commitments made to Buyer in writing, and Seller shall have no liability for any loss, damage or injury which Buyer may sustain or for which Buyer may be liable. Buyer is solely responsible for the operation of Buyer's systems, including ensuring that the systems are operated and maintained properly and comply with all laws, rules, regulations, license conditions and orders. Seller will not operate, inspect or maintain Buyer's systems or act as a licensed operator as defined by local regulatory authorities.
3. **Delivery.** Title and risk of loss or damage to Goods as well as containers and tanks in which Goods are contained, except as provided for in section 8 of this Agreement, shall pass to Buyer upon delivery to carrier at designated shipping point. Delivery dates indicated by Seller are only approximate. Quotations and proposal drawings provided by Seller show only general style, arrangement and approximate dimensions and weight.
4. **Payment and Prices.** Unless otherwise specified in writing, payment is due net thirty (30) days from the date of Seller's invoice. If Seller shall have any doubt at any time as to Buyer's ability to pay, Seller may decline to make deliveries except on receipt of satisfactory security. The prices quoted herein do not include taxes. Buyer shall be directly responsible, and reimburse Seller, for the gross amount of any present or future sales, use, excise, value-added, or other similar tax applicable to the price, sale of delivery of any products or services furnished hereunder. Buyer shall furnish Seller with evidence of exemption acceptable to the taxing authorities if applicable. For multi-year agreements, pricing stated shall remain firm for 12 months, after which Seller shall be entitled to adjust pricing upward on an annual basis according to the designated formula used by Seller in Buyer's country and which shall be notified to Buyer. Unless otherwise specified, all prices are FOB point of shipment. Buyer agrees to reimburse Seller for collection costs, including 2% interest per month, should Buyer fail to timely pay. Buyer shall have no rights to any setoffs of any nature relating to any payments due under the Agreement. Notwithstanding the terms set forth herein or of any agreement acceptance of Seller's quotation, Seller reserves the right at any time and from time to time by notice in writing to the Buyer to (a) increase Prices (or impose temporary price adjustments) based on increases in the cost of base components for the Goods or Services provided, where the increase is due to increased global demand, limited supply, temporary product shortages, allocation of supply, or such other similar inflationary pressures; and (b) impose a surcharge equal to any increase in the cost of the Goods or Services as a result of a modification of exchange rates, taxes or other levies imposed by public authorities.
5. **Payment for Excessive Usage; Lost and Damaged Goods.** If payment for Goods is based on some factor other than the actual amount of Goods delivered (e.g., payment is for a fixed amount, or based on usage or production), then Buyer agrees to pay for all Goods (a) consumed as a result of Buyer's failure to comply with Obligations as set forth in Section 2; or (b) lost or damaged after delivery to Buyer. Buyer shall provide Seller all information necessary to calculate amounts due and enable Seller to audit those records.
6. **Consigned Goods.** Buyer shall bear all risk of loss and damage to all consigned Goods in Buyer's possession or control, notwithstanding Buyer's exercise of reasonable care. Seller shall have the right to enter Buyer's premises at all reasonable times to inspect such Goods and related records. Upon request, Buyer agrees to return such Goods to Seller pursuant to Seller's shipping instructions.
7. **Limited Warranties.** Seller warrants that the Goods shall conform to published specifications and shall be free from defects in material and workmanship when at all times operated in accordance with Seller's written instructions; and that the Services will be performed with the degree of skill which can reasonably be expected from a seller engaged in a comparable business and providing comparable services under comparable circumstances. Under no circumstances do Services include the operation, inspection or maintenance of Buyer's systems or acting as a licensed operator as defined by local regulatory authorities. Unless otherwise provided in any Warranty Schedule that may be attached hereto, the foregoing warranties are valid: (a) for Chemicals, the earlier of, the shelf-life of the product, or 6 months from their date of delivery or the provision of Services; (b) for Consumables, including Filters and Membranes, 12 months from their date of delivery; (c) for Goods other than Chemicals and Consumables, the earlier of, 15 months from receipt, or 12 months from start-up/first use. Unless expressly agreed in a "Performance Warranty Document" signed between the parties on a separate basis, there is no performance warranty on Goods and Services or warranty on process results. For Goods not manufactured by Seller, the warranty shall be the manufacturer's transferable warranty only. Any claim for breach of these warranties must be promptly notified in writing or the claim will be void. Seller's sole responsibility and Buyer's exclusive remedy arising out of or relating to the Goods or Services or any breach of these warranties is limited to, at Seller's option: (a) replacement of non-conforming Goods or refund of purchase price of the non-conforming Goods; and (b) re-performance of the Services at issue, or a refund of the amount paid for the Services at issue. No allowance will be made for repairs or alterations made by Buyer without Seller's written consent or approval. Goods may not be returned to Seller without Seller's written permission. Seller will provide Buyer with a "Return Material Order" number to use for returned goods. Buyer, as the original purchaser, is not entitled to extend or transfer this warranty to any other party. The foregoing warranties are in lieu of and exclude all other warranties, statutory, express or implied, including any warranty of merchantability or of fitness for a particular purpose.
8. **Use of Equipment, Tanks, and Containers.** Semi-bulk containers (SBCs) owned by Seller shall be used only for the storage of Goods approved by Seller and Buyer shall return to Seller all SBCs owned by the Seller in an "empty" condition, as defined by appropriate transport or environmental regulations. Title to, and risk and ownership of, all equipment, product containers (e.g., pails, drums, recyclable intermediate bulk containers "IBC"), and tanks supplied to Buyer shall pass to Buyer as provided for in Section 3 of this Agreement, except that returnable SBCs shall remain property of Seller, unless otherwise stated in Seller's documentation.
9. **Compliance With Laws; Permits.** Buyer is responsible for compliance with all laws and regulations applicable to the operations of its systems and to the storage, use, handling, installation, maintenance, removal, registration and labeling of all Goods from and after Buyer's receipt of the Goods, as well as for the proper management and disposal of all waste and residues associated with the Goods (including but not limited to containers, excess or off-spec product, testing wastes (e.g., spent or expired lab reagents and test kits) and signing manifests for waste transport and disposal. Buyer agrees to ensure that all Goods and Services provided to Buyer for export are exported only in compliance with applicable export control laws and regulations. Permits and licenses which are required to operate apparatus or equipment or to use the Goods, shall be procured by Buyer at Buyer's sole expense. Buyer shall be responsible for and procure all permits, licenses, exemptions, authorizations and approvals necessary to the operation of its systems, including but not limited to permits related to liquid and solid waste handling and discharge, air and water emissions, sound, safety, etc. Seller shall not be liable if any such permit, license, exemption, authorization or approval is delayed, denied, revoked, restricted, violated or not renewed and Buyer shall not be relieved thereby of its obligations to pay Seller in accordance with this Agreement.
10. **Force Majeure.** Neither party will be responsible to the other (and no event of default will be deemed to have occurred) if uncontrollable events make it impracticable or commercially unreasonable for either party to perform under the terms of this Agreement, provided no force majeure shall apply to Buyer's obligation to pay in a timely manner for Goods and Services. Scheduled delivery dates are subject to extension when a force majeure event occurs.
11. **Confidentiality and Intellectual Property.** Both parties agree to keep confidential the other party's proprietary non-public information, if any, which may be acquired in connection with this Agreement. Buyer will not, without Seller's advance written consent, subject Goods to testing, analysis, or any type of reverse engineering. Seller retains all intellectual property rights including copyright which it has in all drawings and data or other deliverables supplied or developed under this Agreement subject

to Buyer's right to use such drawings and data for its own use without additional cost. Buyer acknowledges that Seller is in the business of selling the Goods subject to this Agreement and agrees that it will not file patent applications on the Goods, or processes and methods of using the Goods, without Seller's express written permission. Buyer further agrees that in any event any such patents will not be asserted against Seller or its customers based upon purchase and use of such Goods. Buyer shall be fully liable for any infringement of patent rights of third parties arising out of the products supplied hereunder where the construction, and other characteristics of such products including modification of the Goods and Services, is prescribed to the Seller, or completed independently by the Buyer or agent(s). Buyer shall fully defend and indemnify the seller in case of such claim(s). Any software Seller owns and provides pursuant to this Agreement shall remain Seller's property. Seller provides to buyer a limited, non-exclusive and terminable license to such software for the term of this Agreement. Buyer agrees not to copy, sub-license, translate, transfer, reverse engineer, or decode the software. Unless otherwise expressly agreed by Seller, this license shall terminate and the software shall be returned to Seller upon termination of this Agreement, or the material breach of the terms in this section. Buyer shall defend and indemnify Seller in respect of any claim or liability suffered by Seller in connection with infringement of any third party rights based on design, specifications or requirements prescribed by Buyer or its agent.

12. Limitation on Liability. Except where expressly communicated to Seller, Seller shall have no liability for incompatibility of Goods with Buyer's actual space or design limitations. To the extent permitted by law, the total liability of the Seller for all claims arising out of or relating to the performance or breach of this Agreement or use of any Goods Services shall not exceed the annual contract value of this Agreement. Seller shall not be liable for any advice, instruction, assistance or any services that are not required under this Agreement or for which Seller does not charge Buyer. In no event will either party be liable to the other for lost profits or revenues, cost of capital or replacement or increased operating costs, lost or decreased production, claims of Buyer's customers for such damages or any similar or comparable damages, or for any incidental, special, consequential or indirect damages of any type or kind, irrespective of whether arising from actual or alleged breach of warranty, indemnification, product liability or strict liability, or any other legal theory. If Buyer is supplying Seller's Goods or Services to a third party, Buyer shall require the third party to agree to be bound by this clause. If Buyer does not obtain this agreement for Seller's benefit for any reason, Buyer shall indemnify and hold Seller harmless from all liability arising out of claims made by the third party in excess of the limitations and exclusion of this clause.

13. Conflicts; Survival, Assignment. If there is any conflict between this Agreement and any written proposal or quotation provided by Sellers, then the terms and conditions set forth in the proposal or quotation shall prevail. If any term or condition of this Agreement or any accompanying terms and conditions are held invalid or illegal, then such terms and conditions shall be reformed to be made legal or valid, or deleted, but the remaining terms and conditions shall remain in full force and effect, and the Agreement shall be interpreted and implemented in a manner which best fulfills our intended agreement. This Agreement may only be assigned by Seller to any affiliate.

14. Termination and Cancellation. This Agreement and any performance pursuant to it may be terminated or suspended by either party if the other party (a) is the subject of bankruptcy or insolvency proceedings; or (b) defaults in its material obligations under this Agreement, and such default is not cured within thirty (30) days. Upon the termination of this Agreement: (a) Buyer agrees to pay for all Goods in Buyer's possession or for which title has passed to Buyer, at current prices or at such other prices as have been agreed to in writing; and (b) all amounts owing, if any, for the equipment or tanks relating to those Goods shall immediately become due and shall be paid within thirty (30) days of receipt of an invoice. In the event of cancellation of an order by Buyer, a cancellation charge will be made against the Buyer, in proportion to the work completed by Seller, or obligated against the order, plus any cancellation charges assessed against Seller by Seller's suppliers.

15. Governing Law and Dispute Resolution. This Agreement shall be governed by the substantive laws of the State of New York. The UN Convention on the International Sale of Goods shall not apply. In the event of a dispute concerning this Agreement, the complaining party shall notify the other party in writing thereof. Management level representatives of both parties shall meet at an agreed location to attempt to resolve the dispute in good faith. Should the dispute not be resolved within thirty (30) days after such notice, the complaining party shall seek remedies exclusively through arbitration. The seat of arbitration shall be the federal district court in Philadelphia, PA, and the rules of the arbitration will be the Commercial Arbitration Rules of the American Arbitration Association, which are incorporated by reference into this clause.